

hooked

Montage instructie
Assembling instruction
Montageanleitung
Instructions de montage
Emballage instruktioener
Instrukcja montażu



CXA3

1.

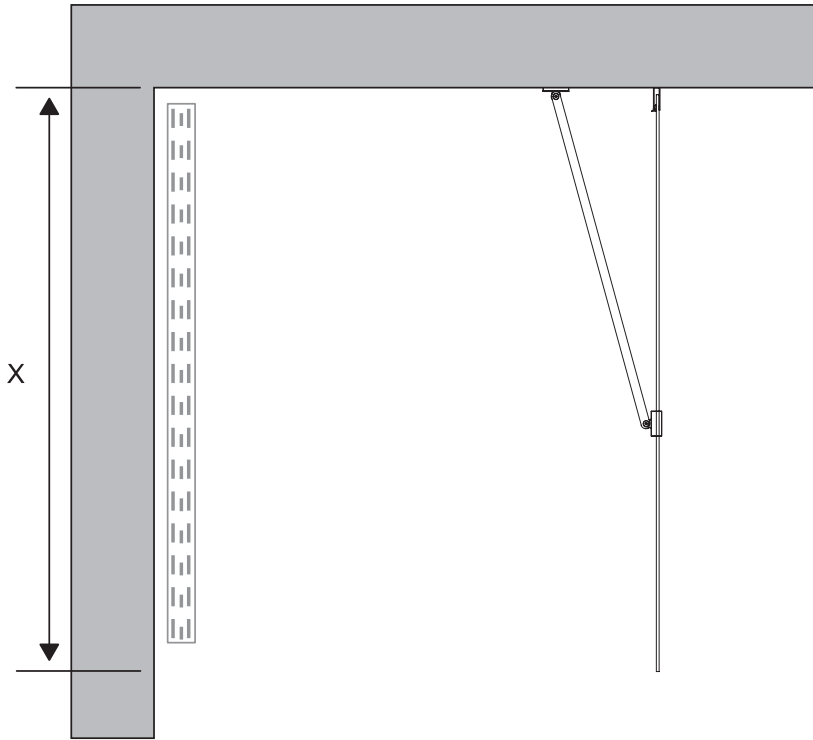

	X
75	740-760 mm
90	870-890 mm
120	1170-1190 mm
140	1370-1390 mm

additional tools

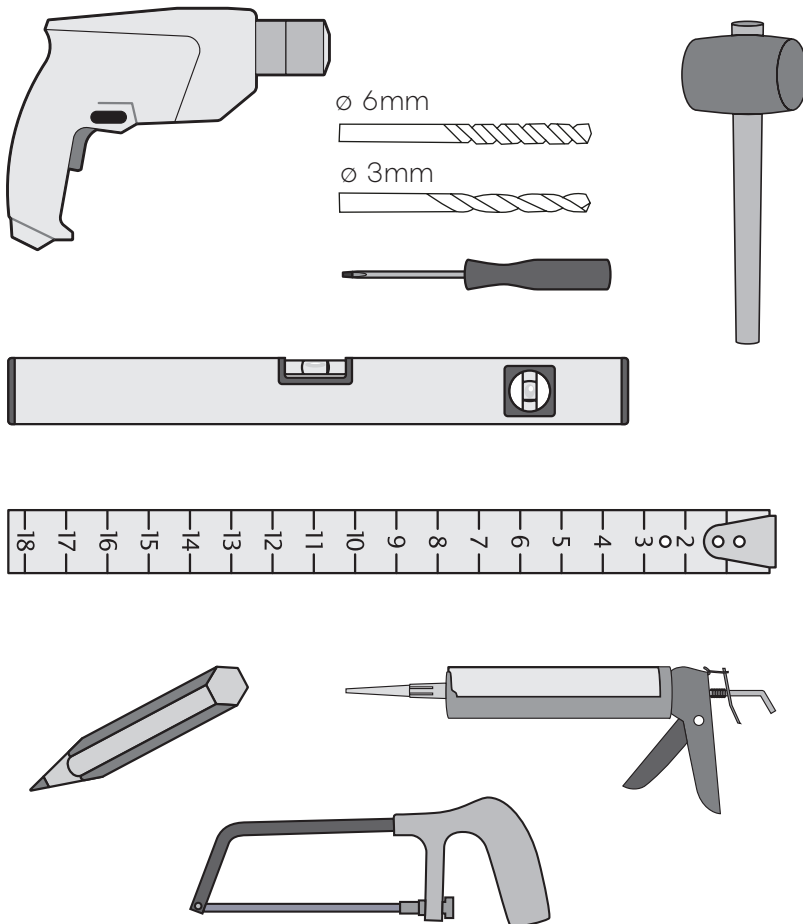

included

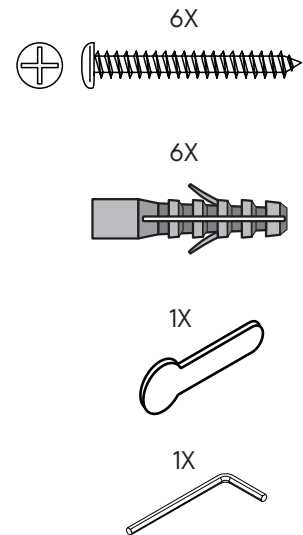

2.

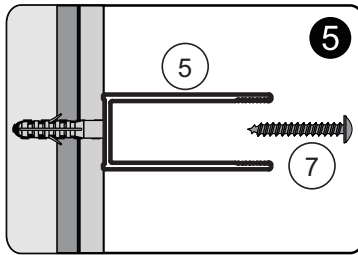
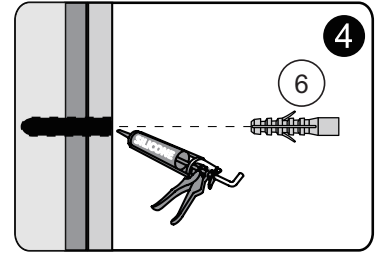
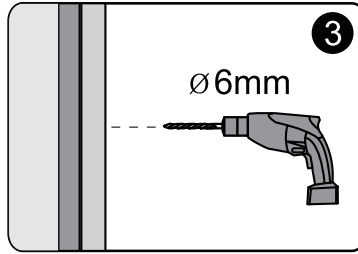
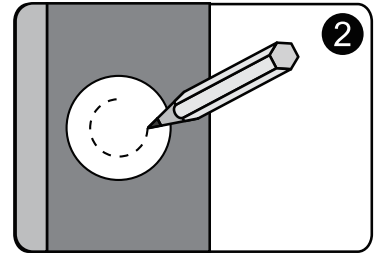
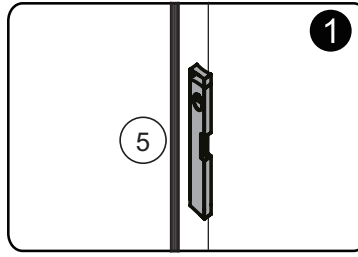
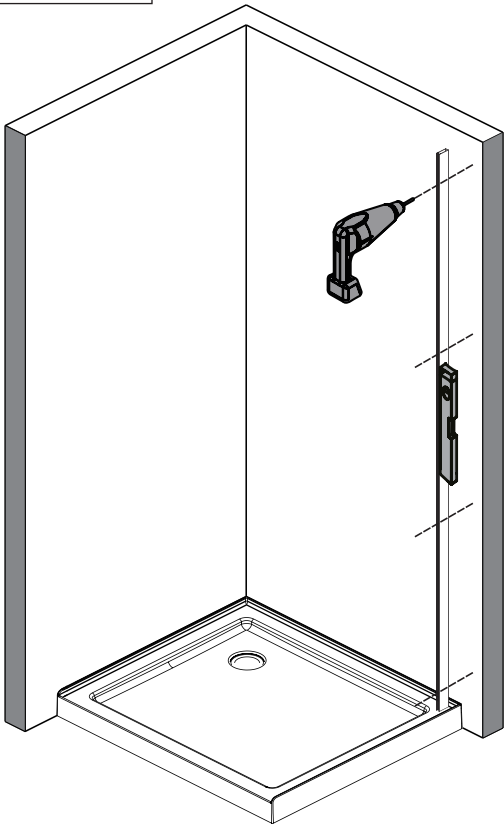

3.

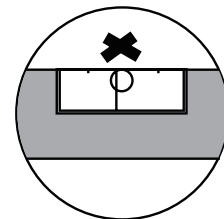
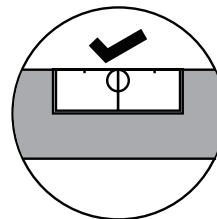
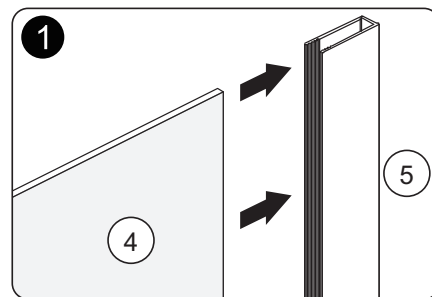
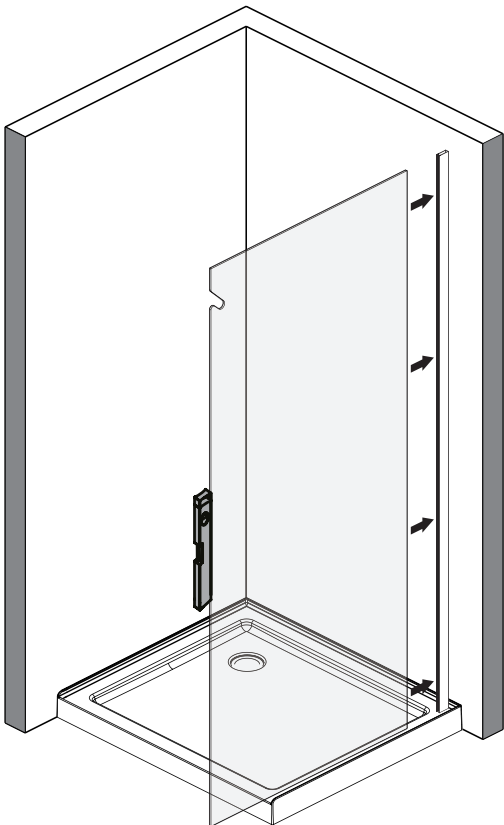

4.

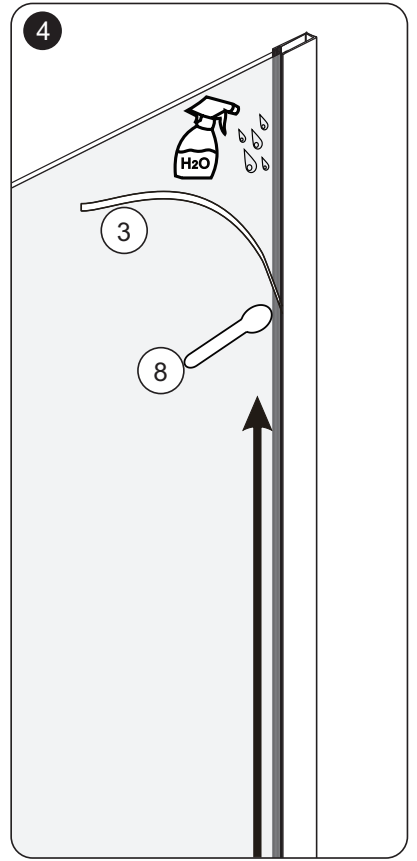
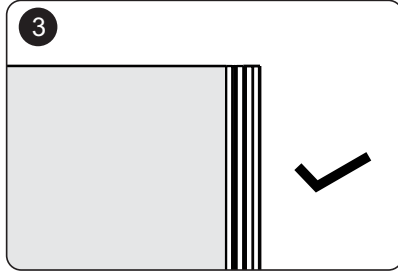
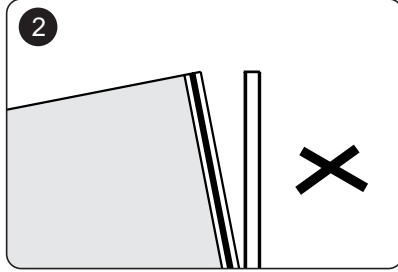
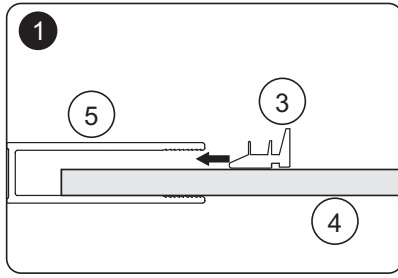
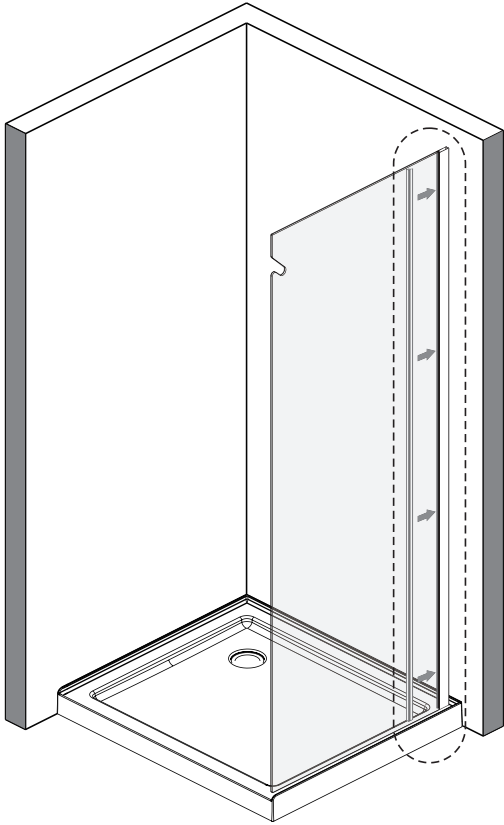

5.

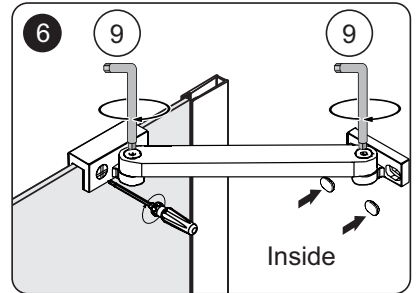
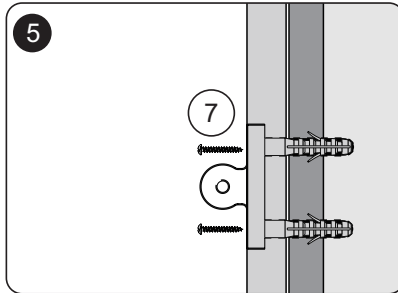
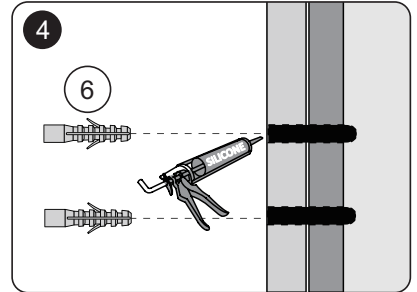
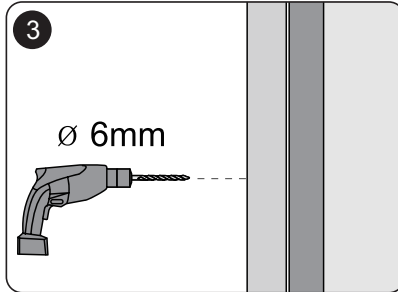
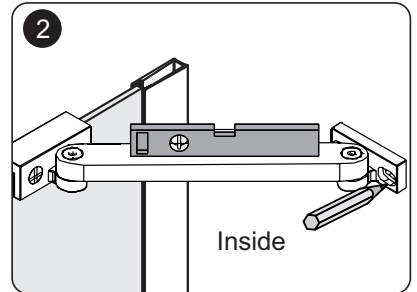
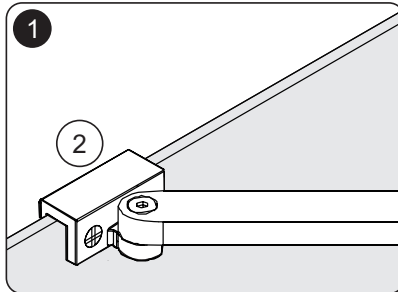
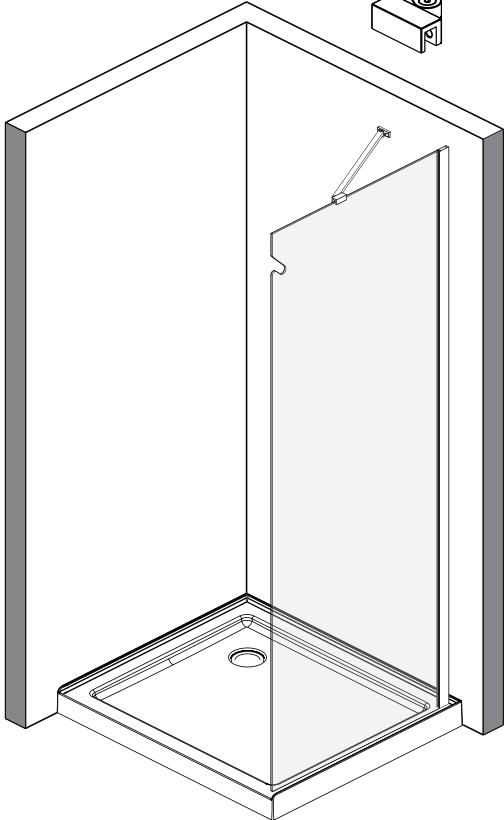
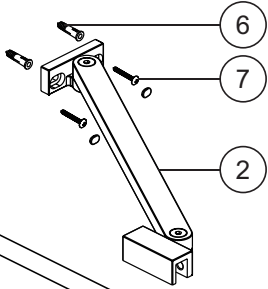

6.

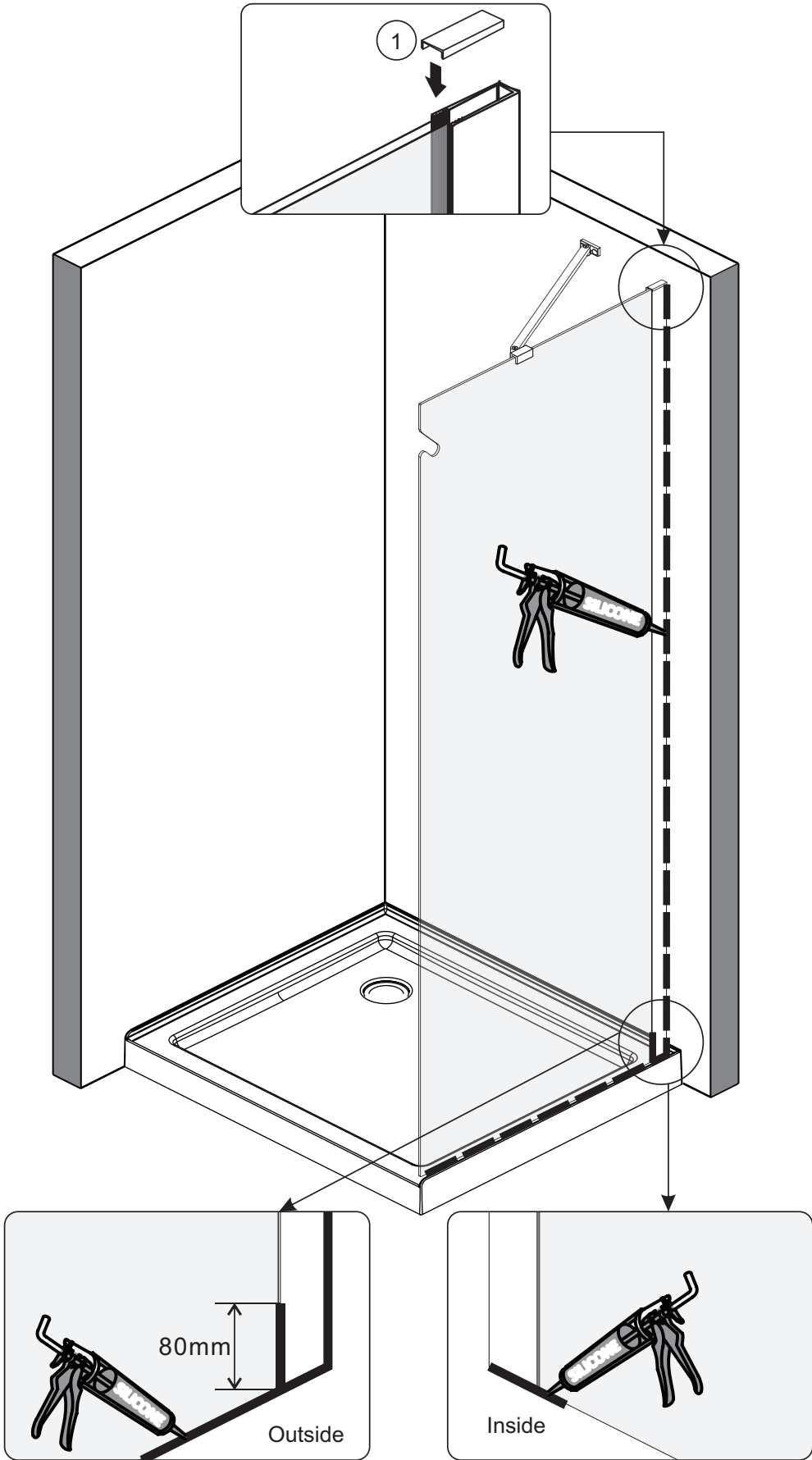
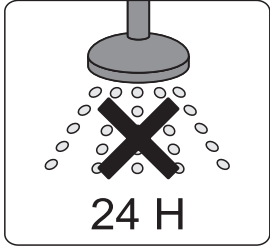

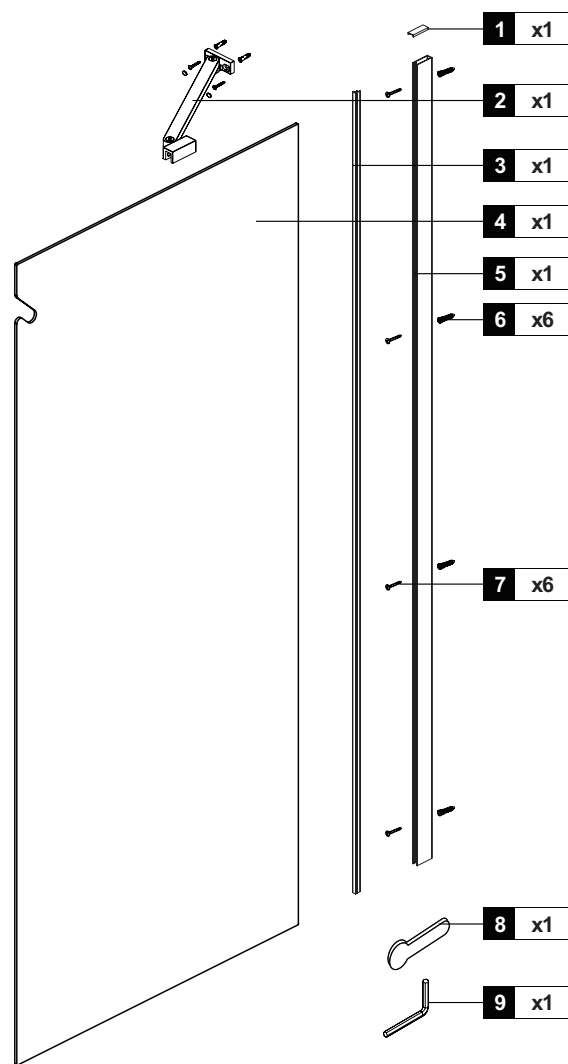

NO	Qty	Description	NO	Qty	Description
1	1	Fixed panel profile top cover	6	6	Wall anchor
2	1	Wall bracket	7	6	Screw ST4X40
3	1	Squeeze gasket tool	8	1	Squeeze gasket
4	1	Clear fixe panel	9	1	Allan key kit
5	1	Chrome Wall Channel			

NL Voor de reiniging dient u een PH neutraal reinigingsmiddel of de aanbevolen Sealskin douchereiniger te gebruiken. Geen verdunner, alkalische, zuur, chloor of schurende middelen gebruiken.

GB For cleaning use a pH-neutral cleaning agent or the special cleaner recommended by us. Not to use are solvents, as well as alkaline, solvent -, acid- and chloric or scrubbing agents.

FR Pour nettoyer veuillez utiliser s'il vous plaît un produit de nettoyage avec PH neutre ou le produit spéciale recommandé par nous. N'utilisez pas des solvants, ainsi qu'alcalins, acides ou produits avec du clore ou agressif.

DE Zur Reinigung benutzen Sie ein PH-neutrales Reinigungsmittel oder den von uns empfohlenen Spezialreiniger. Verwenden Sie keine scheuernden, alkalischen, säure- oder chlorhaltigen Reinigungsmittel sowie Oxidations- und Lösungsmittel.

PL Do mycia i pielęgnacji proszę używać środków czyszczących o odczynie PH obojętnym lub polecany przez nas specjalny preparat. Nie należy stosować rozpuszczalników, jak również preparatów alkalicznych, kwaśnych, zawierających chlor lub posiadających w aściwości ściernie.

hooked

Garantiebewijs
Warranty card
Garantieschein
Carte de garantie
Certificato di garanzia
Certificado de garantia

CXA3

This Sealskin get wet product has a warranty period of 5 years. Normal wear and tear on components such as transparent gaskets are excluded from this warranty.

Wholesale dealer:

Adress:

Phone:

Fax:

Installer:

Adress:

Phone:

Fax:

NL De producent houdt zich het recht voor, ten alle tijde zonder tegenbericht, veranderingen door te voeren.
GB The producer reserves the right to modify the product at any time without prior notice.
DE Der Produzent behält sich jederzeit das Recht, ohne Vorbescheid Abänderungen vorzunehmen.
FR Le producteur se réserve le droit de modifier le produit sans aucun préavis.
SV Tillverkaren förbehåller sig all rätt att produktförändra
PL Producent rezerwuje sobie prawo modyfikacji produktu bez wczesniejszego powiadomienia.