

7

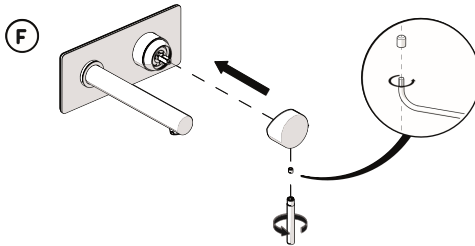

8

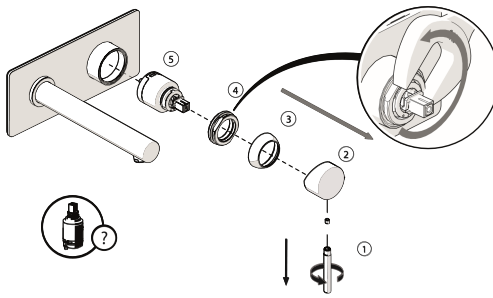

No limitation of temperature

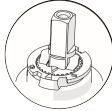

Partial limitation of temperature

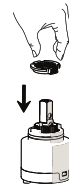
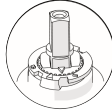

Maximum position Only cold water

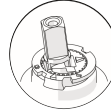

9

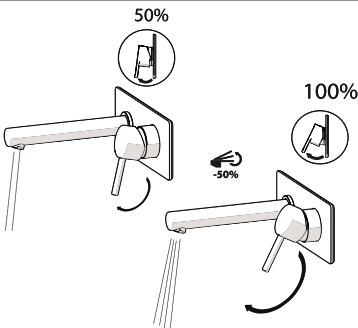

10

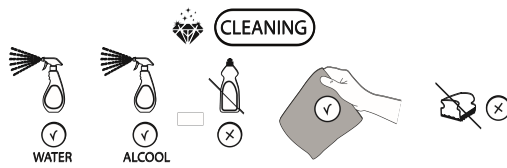

ISTALV001984--STD

NOBILIS
The Best Technology for Water

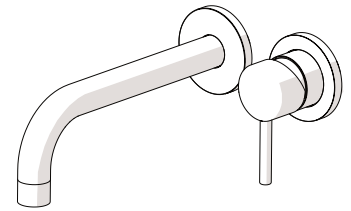
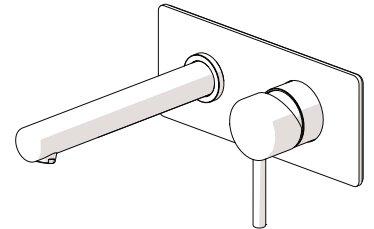

LV00198

LV00198_1

