

Easy Drain®

Modulo

M1 & M2 | Basic & TAF



TAF

BASIC

WPS

0,40 l/s
MIN. CAPACITY

0,70 l/s
MAX. CAPACITY

UK **INSTALLATION ADVICE**

DE Einbauempfehlung

NL Inbouwadvies

DK Montagevejledning

NO Innbyggingsråd

ES Consejo para la instalación

PT Conselho de instalação

IT Consigli di montaggio

FR Conseils de montage

PL Zalecenia dotyczące wbudowania

UK Contents
DE Inhalt
NL Inhoud
DK Indhold
NO Innhold

ES Contenido
PT Conteúdo
IT Contenuto
FR Table des matières
PL Zawartość

Installation options	3
Installation guide	4
Installation guide Wall	5
Sealing	6
Sealing Wall	7
Frame & Grating TAF	8
Frame & Grating Basic	9
Sealing advice TAF (primary drainage)	10
Sealing advice TAF (secondary drainage).....	11
Sealing advice Basic	12
Maintenance instructions	13
Siphon cleaning	14
TAF Extension set	15
Installation example	16
Important assembling advice	18



Modulo **M1**



Modulo **M2**

UK Installation options
DE Einbaumöglichkeiten
NL Inbouwvarianten
DK Installeringsvarianter
NO Innbyggingsvarianter

ES Opciones de instalación
PT Variantes de instalação
IT Varianti di montaggio
FR Variantes de montage
PL Warianty wmontowania

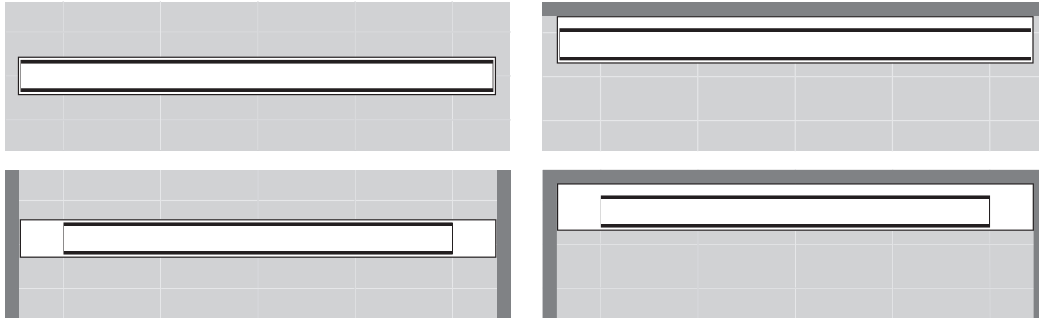

BASIC		
TAF (Z1)		
TAF WALL		
TAF DESIGN (Z2)		
TAF DESIGN (Z3)		
TAF DESIGN (Z4)		

UK Installation guide
DE Einbauempfehlung
NL Inbouwhandleiding
DK Montagevejledning
NO Innbyggingsveiledning

ES Manual de instalación
PT Instruções de instalação
IT Istruzioni di montaggio
FR Explications de montage
PL Instrukcja wmontowania

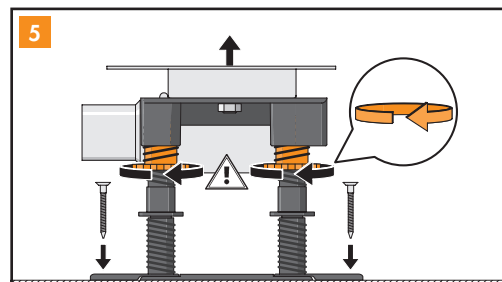
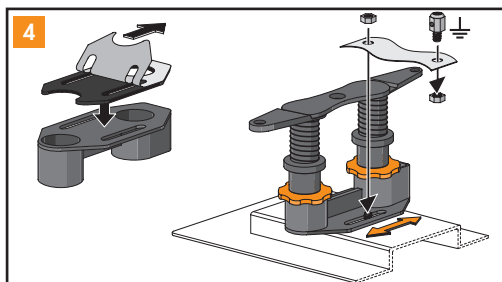
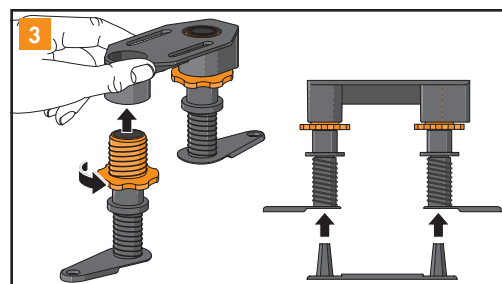
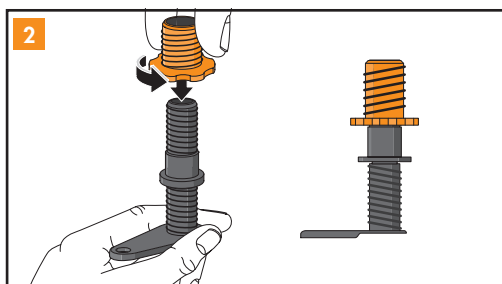
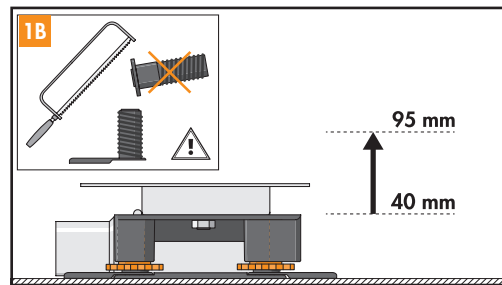
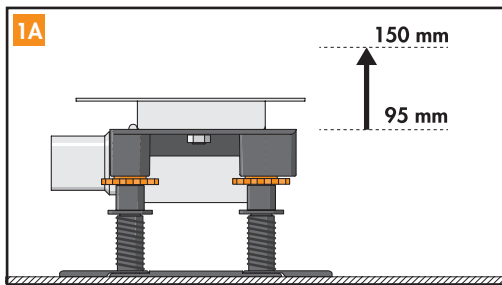

UK Installation guide | Wall
 DE Einbauanleitung | Wand
 NL Inbouwhandleiding | Wand
 DK Montagevejledning | Væg
 NO Innbyggingsveiledning | Vegg

ES Manual de instalación | Pared
 PT Instruções de instalação | Parede
 IT Istruzioni di montaggio | Parete
 FR Explications de montage | Mur
 PL Instrukcja wmontowania | Ściana

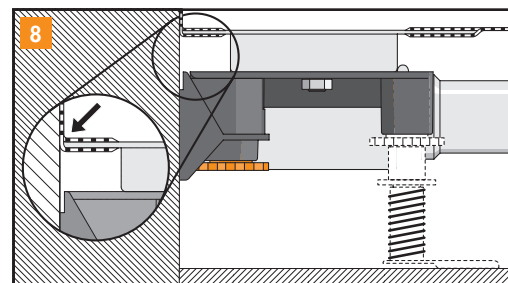
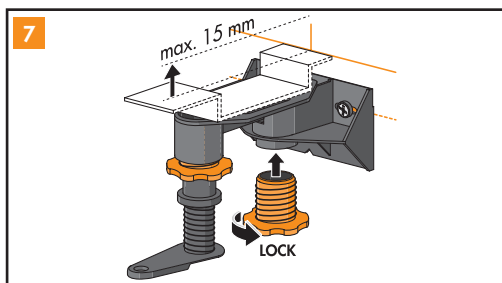
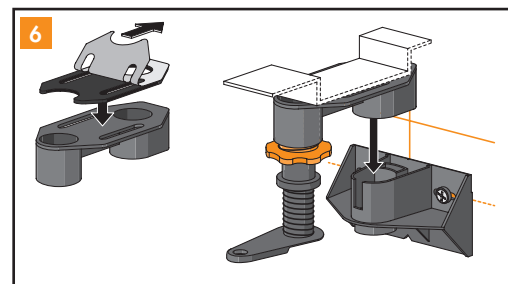
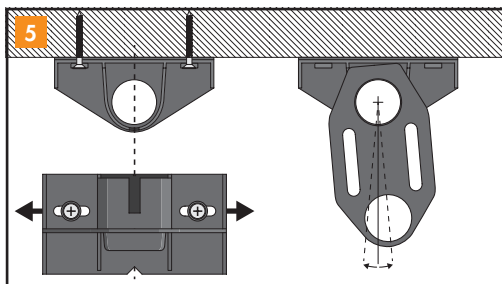
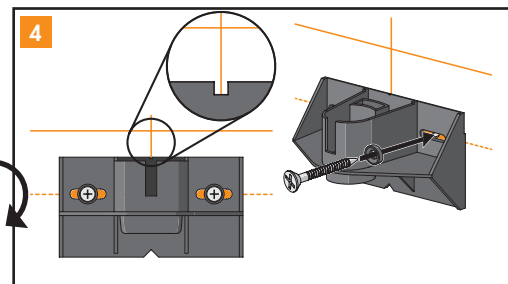
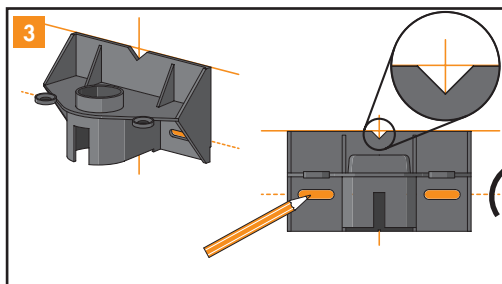
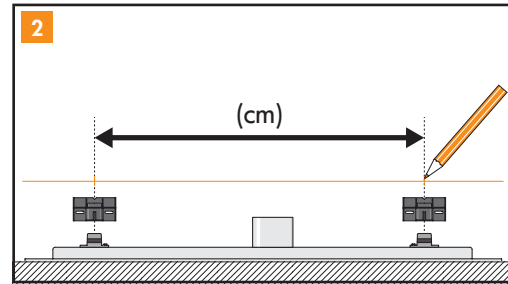
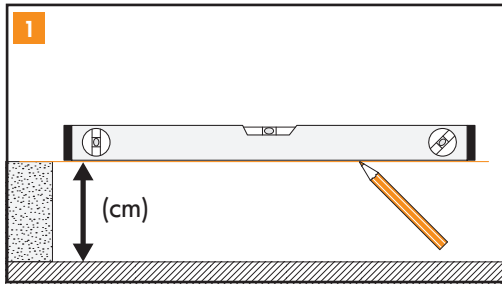

UK Sealing
 DE Abdichtung
 NL Afdichting
 DK Tætning
 NO Tetning

ES Sellado
 PT Vedação
 IT Sigillatura
 FR Étanchéifier
 PL Uszczelniania

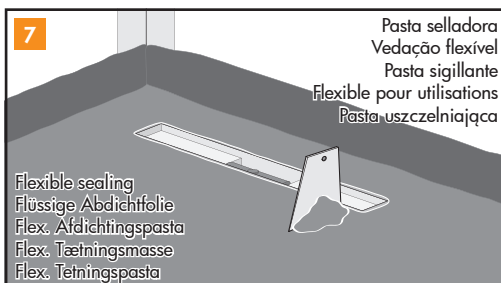
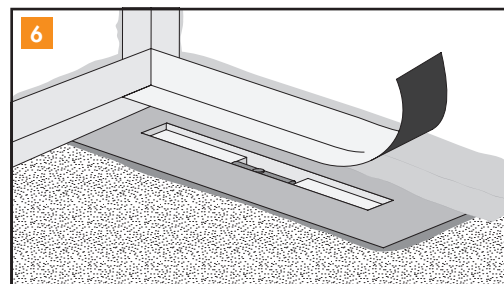
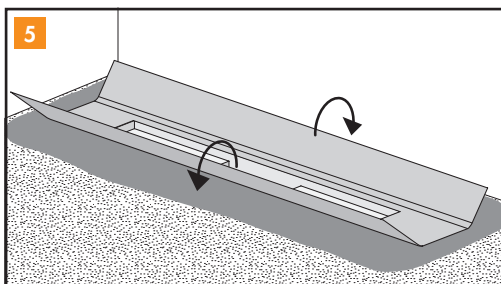
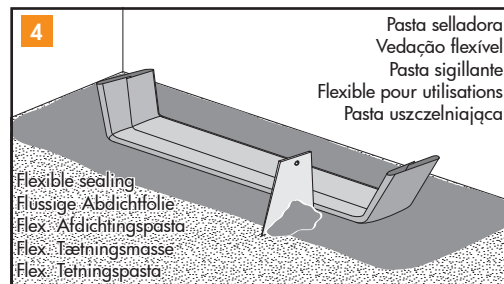
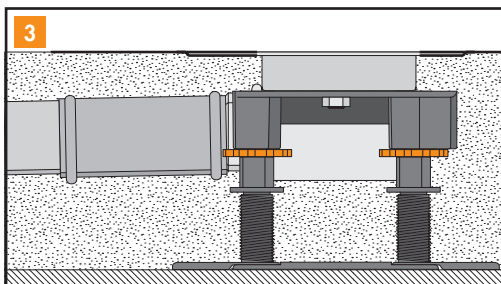
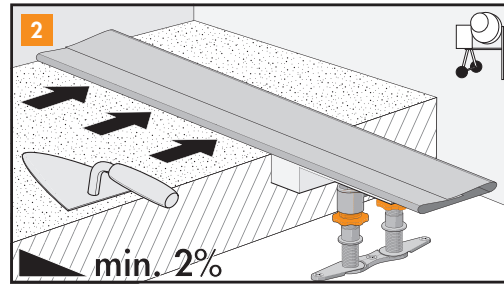
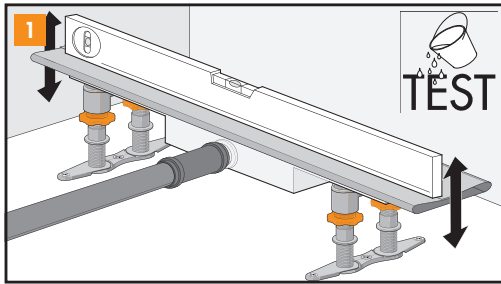

UK Sealing | Wall
 DE Abdichtung | Wand
 NL Afdichting | Wand
 DK Tætning | Væg
 NO Tetning | Vegg

ES Sellado | Pared
 PT Vedação | Parede
 IT Sigillatura | Parete
 FR Étanchéifier | Mur
 PL Uszczelniania | Ściana

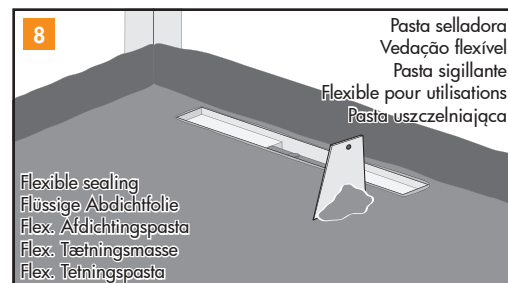
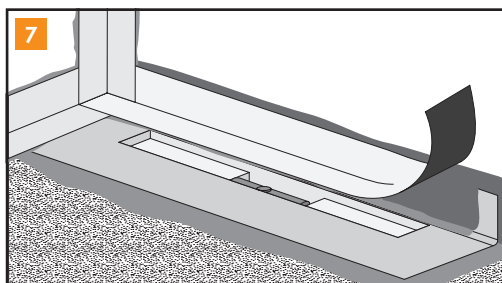
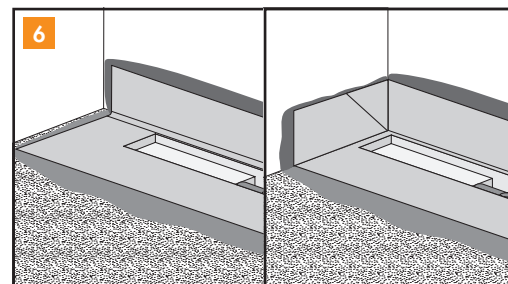
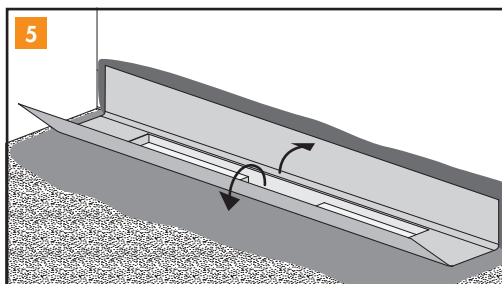
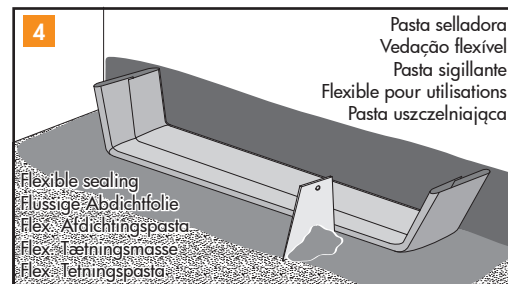
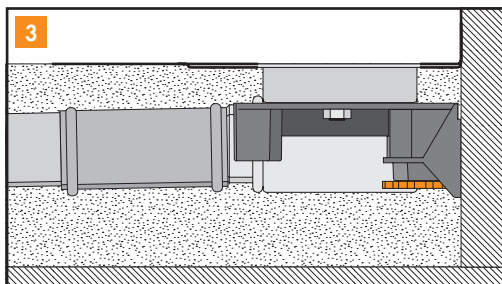
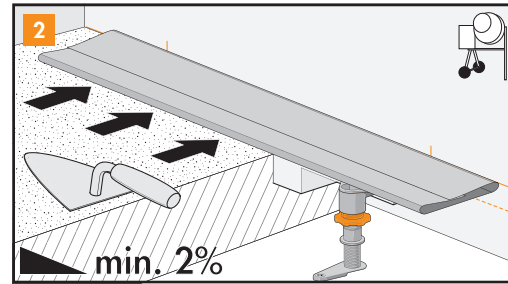
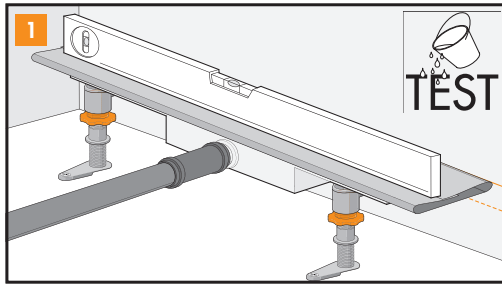

UK Frame & grating | TAF
 DE Rahm & Abdeckung | TAF
 NL Frame & rooster | TAF
 DK Rammen & rist | TAF
 NO Ramme & rist | TAF

ES Marco & Rejilla | TAF
 PT Estrutura & grelha | TAF
 IT Telaio & griglia | TAF
 FR Cadre & grille | TAF
 PL Rama & kratka | TAF

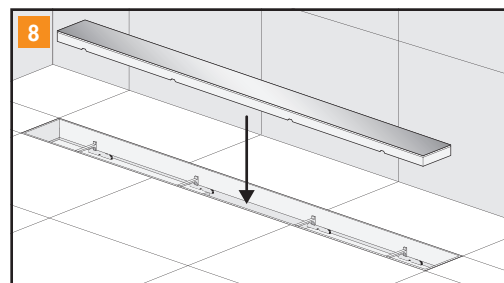
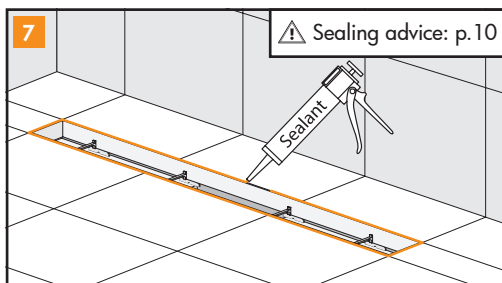
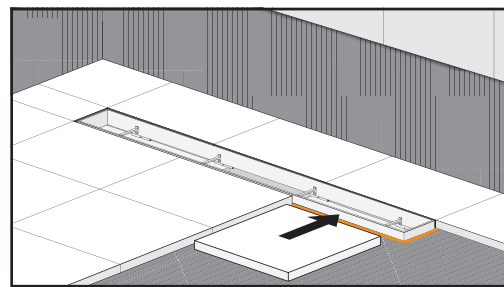
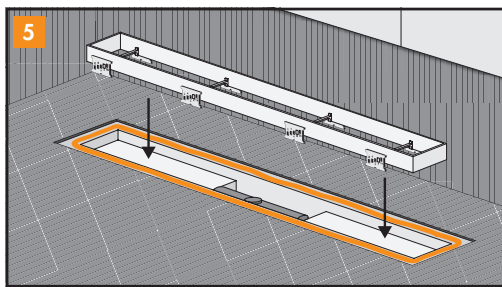
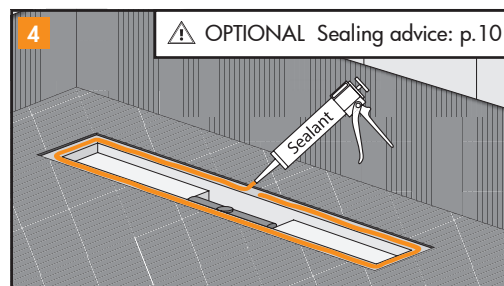
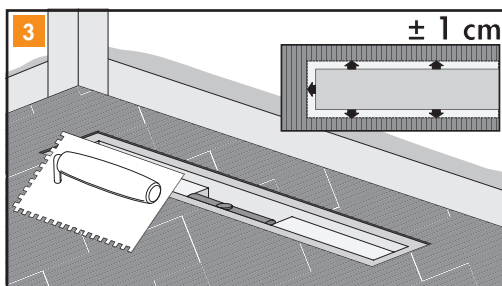
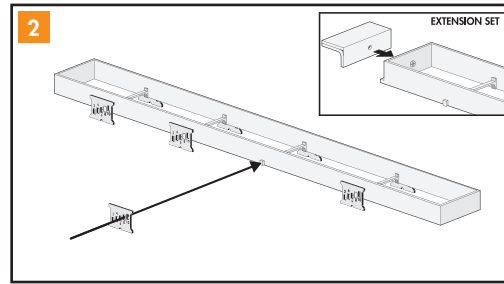
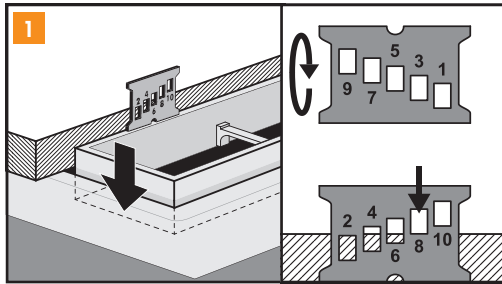

UK Frame & grating | BASIC
DE Rahm & Abdeckung | BASIC
NL Frame & rooster | BASIC
DK Rammen & rist | BASIC
NO Ramme & rist | BASIC

ES Marco & Rejilla | BASIC
PT Estrutura & grelha | BASIC
IT Telaio & griglia | BASIC
FR Cadre & grille | BASIC
PL Rama & kratka | BASIC

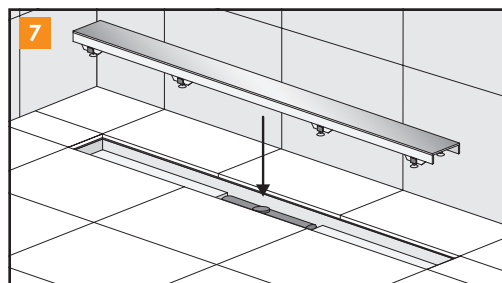
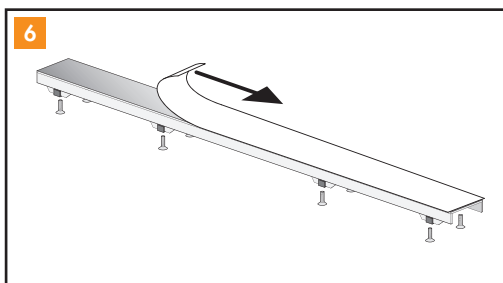
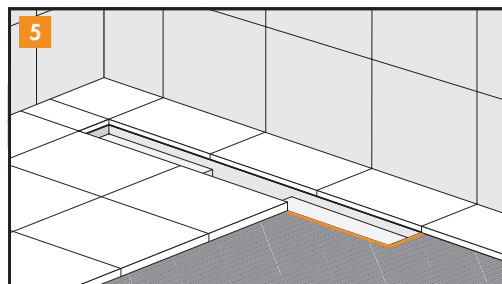
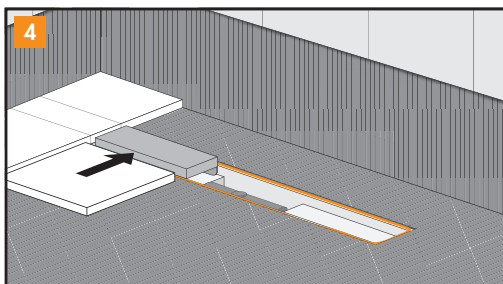
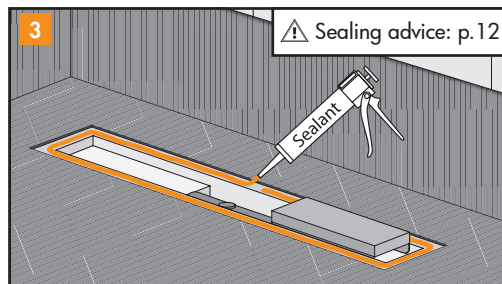
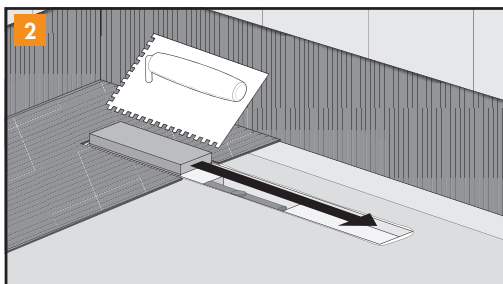
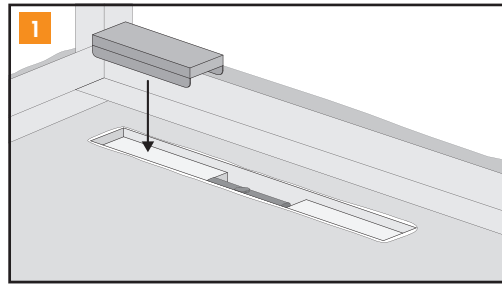
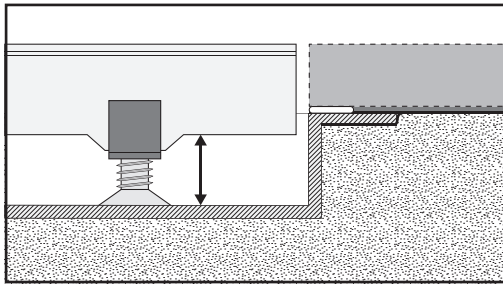

UK Sealing advice | TAF

DE Abdichtungsempfehlung | TAF

NL Afdichtingsadvies | TAF

DK Tætningsråd | TAF

NO Tetningsråd | TAF

ES Consejo de sellado | TAF

PT Conselho de vedação | TAF

IT Consigli per la sigillatura | TAF

FR Conseil pour étanchéifier | TAF

PL Zalecenia dotyczące uszczelniania | TAF



UK Only primary drainage

DE Nur Primärwasser Ableitung

NL Alleen primaire afwatering

DK Kun afledning af primærvand

NO Kun primær avløp

ES Sólo desagüe de agua primario

PT Só drenagem da água primária

IT Solo derivazione primario scarico

FR Seule évacuation primaire

PL Podstawowy systemu odpływowego

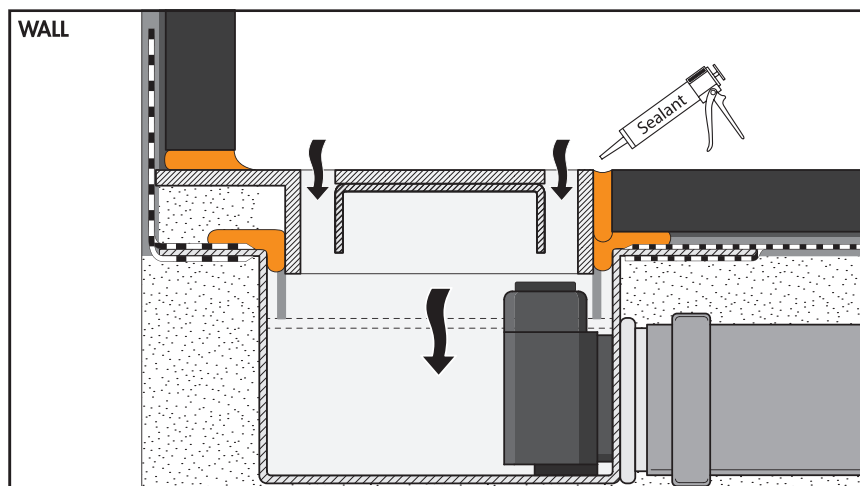
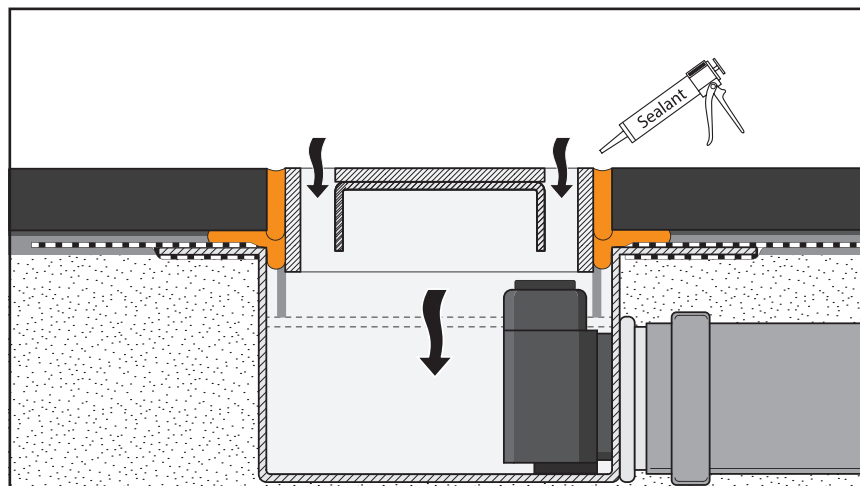

UK Sealing advice | TAF

DE Abdichtungsempfehlung | TAF

NL Afdichtingsadvies | TAF

DK Tætningsråd | TAF

NO Tetningsråd | TAF

ES Consejo de sellado | TAF

PT Conselho de vedação | TAF

IT Consigli per la sigillatura | TAF

FR Conseil pour étanchéifier | TAF

PL Zalecenia dotyczące uszczelniania | TAF



UK With secondary (undertile) drainage

DE Mit Sekundärwasser Ableitung

NL Met secundaire afwatering

DK Med afledning af sekundærvand

NO Med sekundær avløp

ES Con desagüe de agua secundario

PT Com drenagem da água secundária

IT Con derivazione secondo scarico

FR Avec évacuation secondaire

PL Z drugorzędneho systemu odpływowego

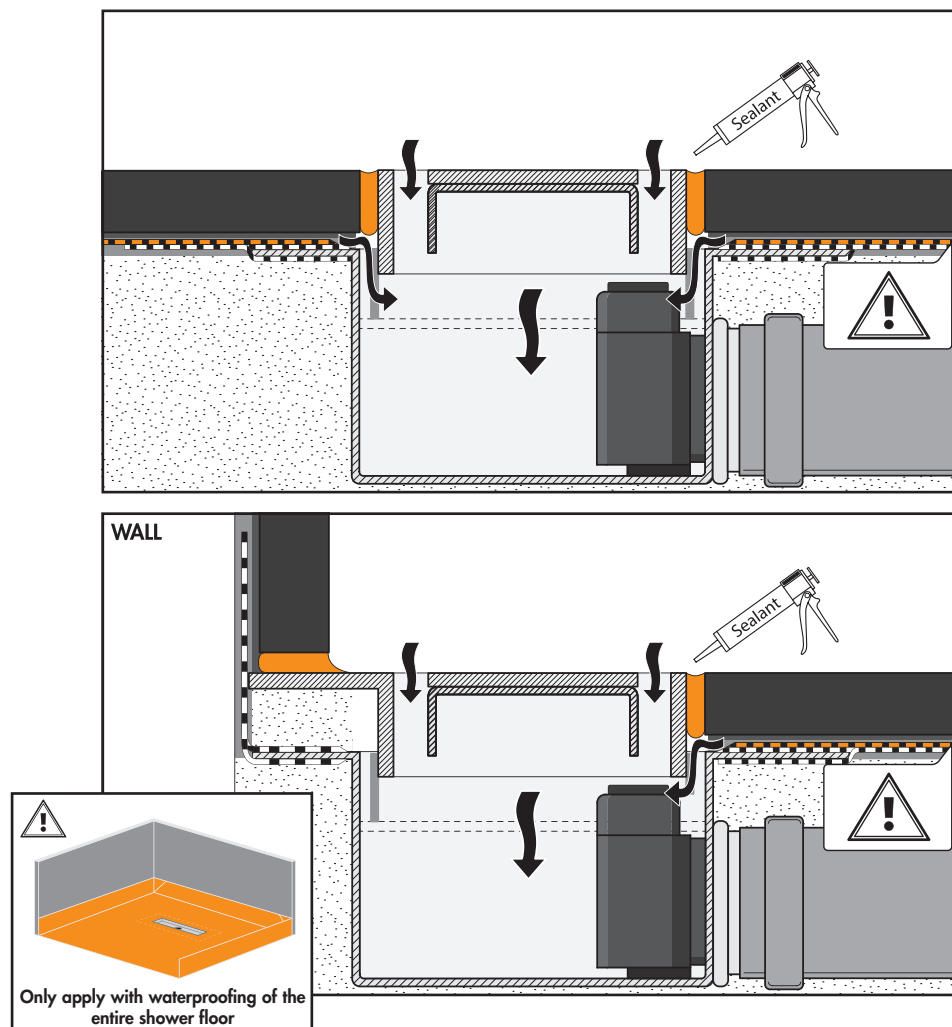

UK Sealing advice | BASIC
DE Abdichtungsempfehlung | BASIC
NL Afdichtingsadvies | BASIC
DK Tætningsråd | BASIC
NO Tetningsråd | BASIC

ES Consejo de sellado | BASIC
PT Conselho de vedação | BASIC
IT Consigli per la sigillatura | BASIC
FR Conseil pour étanchéifier | BASIC
PL Zalecenia dotyczące uszczelniania | BASIC



UK Only primary drainage
DE Nur Primärwasser Ableitung
NL Alleen primaire afwatering
DK Kun afledning af primærvand
NO Kun primær avløp

ES Sólo desagüe de agua primario
PT Só drenagem da água primária
IT Solo derivazione primario scarico
FR Seule évacuation primaire
PL Podstawowy systemu odpływowego

