

<b>DE</b>	Gebrauchsanleitung / Montageanleitung	2
<b>FR</b>	Mode d'emploi / Instructions de montage	2
<b>EN</b>	Instructions for use / assembly instructions	3
<b>IT</b>	Istruzioni per l'uso / Istruzioni per Installazione	3
<b>ES</b>	Modo de empleo / Instrucciones de montaje	4
<b>NL</b>	Gebruiksaanwijzing / Handleiding	4
<b>DK</b>	Brugsanvisning / Monteringsvejledning	5
<b>PT</b>	Instruções para uso / Manual de Instalação	5
<b>PL</b>	Instrukcja obsługi / Instrukcja montażu	6
<b>CS</b>	Návod k použití / Montážní návod	6
<b>SK</b>	Návod na použitie / Montážny návod	7
<b>ZH</b>	用户手册 / 组装说明	7
<b>HU</b>	Használati útmutató / Szerelési útmutató	8
<b>FI</b>	Käyttöohje / Asennusohje	8
<b>SV</b>	Bruksanvisning / Monteringsanvisning	9
<b>LT</b>	Vartotojo instrukcija / Montavimo instrukcijos	9
<b>HR</b>	Upute za uporabu / Uputstva za instalaciju	10
<b>TR</b>	Kullanım kılavuzu / Montaj kılavuzu	10
<b>RO</b>	Manual de utilizare / Instrucțiuni de montare	11
<b>EL</b>	Οδηγίες χρήσης / Οδηγία συναρμολόγησης	11
<b>SL</b>	Navodilo za uporabo / Navodila za montažo	12
<b>ET</b>	Kasutusjuhend / Paigaldusjuhend	12
<b>LV</b>	Lietošanas pamācība / Montāžas instrukcija	13
<b>SR</b>	Uputstvo za upotrebu / Uputstvo za montažu	13
<b>NO</b>	Bruksanvisning / Montasjeveiledning	14
<b>SQ</b>	Udhëzuesi i përdorimit / Udhëzime rreth montimit	14
<b>RU</b>	Руководство пользователя / Инструкция по монтажу	15
<b>BG</b>	Инструкция за употреба / Ръководство за монтаж	16
<b>AR</b>	دليل الاستخدام / تعليمات التجميع	17

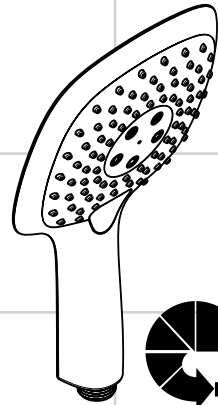

**Raindance Select E 150**  
26551000 / 26551400

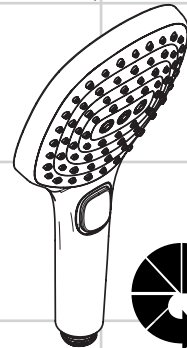

**Raindance Select E 120**  
26521000 / 26521400

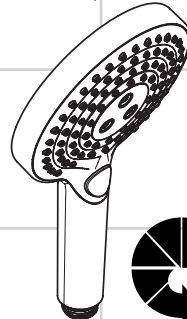

**Raindance Select S 120**  
26531000 / 26531400



## Sicherheitshinweise

- △ Bei der Montage müssen zur Vermeidung von Quetsch- und Schnittverletzungen Handschuhe getragen werden.
- △ Der Kontakt der Brausestrahlen mit empfindlichen Körperstellen (z. B. Augen) muss vermieden werden. Es muss ein ausreichender Abstand zwischen Brause und Körper eingehalten werden.
- △ Die Brause darf nur zur Bade-, Hygiene- und Körperreinigungszwecke eingesetzt werden.

## Montagehinweise

- Die der Brause beige packte Siebdichtung muss eingebaut werden, um Schmutzeinspülungen aus dem Leitungsnetz zu vermeiden. Schmutzeinspülungen können die Funktion beeinträchtigen und/oder zu Beschädigungen an Funktionsteilen der Brause führen, für hieraus ergebende Schäden haftet Hansgrohe nicht.
- Bei einem Druck unter 0,2 MPa (2 bar) darf der eingebaute EcoSmart (Durchflussbegrenzer) aus der Brause entfernt werden. Bei einem Druck über 0,2 MPa darf der EcoSmart nicht entfernt werden.

## Technische Daten

Betriebsdruck:	max. 0,6 MPa
26521XXX Empfohlener Betriebsdruck:	0,2 - 0,4 MPa
26551XXX Empfohlener Betriebsdruck:	0,17 - 0,4 MPa
26531XXX Empfohlener Betriebsdruck:	0,15 - 0,4 MPa
(1 MPa = 10 bar = 147 PSI)	
Heißwassertemperatur:	max. 60°C
Thermische Desinfektion:	max. 70°C / 4 min

Das Produkt ist ausschließlich für Trinkwasser konzipiert!

## Symbolbeschreibung



**Maße** (siehe Seite 19)



**Durchflussdiagramm**  
(siehe Seite 19)



**Bedienung** (siehe Seite 18)



**Serviceteile** (siehe Seite 18)  
XXX = Farbcodierung  
000 = chrom  
400 = chrom/weiß



**Reinigung** (siehe Seite 22) und beiliegende Broschüre



**Prüfzeichen** (siehe Seite 24)

## Montage

siehe Seite 18

## Consignes de sécurité

- △ Lors du montage, porter des gants de protection pour éviter toute blessure par écrasement ou coupure.
- △ Éviter le contact du jet de la douchette avec les parties sensibles du corps (telles par ex. que les yeux). Veiller à respecter un écart suffisant entre la douchette et le corps
- △ La douchette ne doit servir qu'à se doucher, à se nettoyer et à pratiquer une hygiène corporelle.

## Instructions pour le montage

- Le joint à filtre fourni avec la pomme de douche à main doit être installé afin de retenir des impuretés du système de conduites. Ceux-ci pourraient influencer le fonctionnement de ce produit et même endommager des pièces mobiles. Des réclamations à la suite de l'usage de la pomme de douche sans joint-tamis de hansgrohe ne peuvent pas faire partie de notre garantie.
- Lorsque la pression est inférieure à 0,2 MPa (2 bars), l'EcoSmart (limiteur de débit) peut être retiré de la douchette. À une pression supérieure à 0,2 MPa, l'EcoSmart ne doit pas être retiré.

## Informations techniques

Pression de service autorisée:	max. 0,6 MPa
26521XXX Pression de service conseillée:	0,2 - 0,4 MPa
26551XXX Pression de service conseillée:	0,17 - 0,4 MPa
26531XXX Pression de service conseillée:	0,15 - 0,4 MPa
(1 MPa = 10 bar = 147 PSI)	
Température d'eau chaude:	max. 60°C
Désinfection thermique:	max. 70°C / 4 min

Le produit est exclusivement conçu pour de l'eau potable!

## Description du symbole



**Dimensions** (voir pages 19)



**Diagramme du débit**  
(voir pages 19)



**Instructions de service** (voir pages 18)



**Pièces détachées** (voir pages 18)  
XXX = Couleurs  
000 = chromé  
400 = chromé/blanc



**Nettoyage** (voir pages 22) et brochure ci-jointe



**Classification acoustique et débit** (voir pages 24)



## Montage

voir pages 18





## Safety Notes

-  Gloves should be worn during installation to prevent crushing and cutting injuries.
-  Do not allow the streams of the shower touch sensitive body parts (such as your eyes). An adequate distance must be kept between the shower and you.
-  The shower may only be used for bathing, hygiene and body cleansing purposes.

## Installation Instructions

- The mesh washer must be insert to protect the overhead shower against incoming dirt by pipework. Incoming dirt leads to defects or/and can damage parts of the shower; such caused faults voids all liability and guarantee claims.
- For removal of the installed EcoSmart (flow limiter) from the shower, the pressure must be lower than 0.2 MPa. With a pressure of more than 0.2 MPa, the EcoSmart must not be removed.

## Technical Data

Operating pressure:	max. 0,6 MPa
26521XXX Recommended operating pressure:	0,2 - 0,4 MPa
26551XXX Recommended operating pressure:	0,17 - 0,4 MPa
26531XXX Recommended operating pressure:	0,15 - 0,4 MPa
(1 MPa = 10 bar = 147 PSI)	
Hot water temperature:	max. 60°C
Thermal disinfection:	max. 70°C / 4 min

The product is exclusively designed for drinking water!

## Symbol description

**Dimensions** (see page 19)



**Flow diagram**

(see page 19)



**Operation** (see page 18)



**Spare parts**(see page 18)

XXX = Colors

000 = chrome plated

400 = chrome plated/white





**Cleaning** (see page 22) and enclosed brochure

**Test certificate** (see page 24)



**Assembly**  
see page 18

## Indicazioni sulla sicurezza

-  Durante il montaggio, per evitare ferite da schiacciamento e da taglio bisogna indossare guanti protettivi.
-  Bisogna evitare il contatto fra il getto della doccia e parti del corpo delicate (ad es. gli occhi). Fra il soffione ed il corpo va mantenuta una distanza sufficiente.
-  La doccia deve essere impiegata solo per il bagno e utilizzo igienico e pulizia del corpo.

## Istruzioni per il montaggio

- Per proteggere la soffione doccia da eventuali impurità provenienti dalle tubazioni dell'acqua, deve essere inserito il filtro nell'impugnatura della doccia stessa. Tali impurità possono infatti causare difetti e/o danneggiare parti della doccia; in questo caso la Hansgrohe non risponde dei danni.
- Il limitatore di flusso EcoSmart impiegato può essere rimosso dalla doccia se si ha una pressione sotto 0,2 MPa (2 bar). Mentre l'EcoSmart non può essere rimosso con una pressione maggiore di 0,2 MPa.

## Dati tecnici

Pressione d'uso:	max. 0,6 MPa
26521XXX Pressione d'uso consigliata:	0,2 - 0,4 MPa
26551XXX Pressione d'uso consigliata:	0,17 - 0,4 MPa
26531XXX Pressione d'uso consigliata:	0,15 - 0,4 MPa
(1 MPa = 10 bar = 147 PSI)	
Temperatura dell'acqua calda:	max. 60°C
Disinfezione termica:	max. 70°C / 4 min

Il prodotto è concepito esclusivamente per acqua potabile!

## Descrizione simbolo

**Ingombri** (vedi pagg. 19)



**Diagramma flusso**

(vedi pagg. 19)



**Procedura** (vedi pagg. 18)



**Parti di ricambio**(vedi pagg. 18)

XXX = Trattamento

000 = cromato

400 = cromato/bianco



**Pulitura** (vedi pagg. 22) e brochure allegata

**Segno di verifica** (vedi pagg. 24)



**Montaggio**  
vedi pagg. 18





## Indicaciones de seguridad

- ⚠ Durante el montaje deben utilizarse guantes para evitar heridas por aplastamiento o corte.
- ⚠ Debe evitarse el contacto del chorro del pulverizador con partes sensibles del cuerpo (por ej. ojos). Debe mantenerse una distancia suficiente entre pulverizador y cuerpo.
- ⚠ La roseta de ducha solo debe utilizarse para fines de baño, higiene y limpieza corporal.

## Indicaciones para el montaje

- La junta de filtración que se suministra con la ducha mural evita que las partículas de suciedad procedentes de las tuberías lleguen a la ducha mural. Debe colocarse entre el flexo y la ducha mural. Infiltraciones de suciedad deterioran el funcionamiento de la ducha mural y pueden causar daños en el interior de la misma que no están cubiertas por la garantía de Hansgrohe.
- Con una presión inferior a 0,2 MPa (2 bares) se puede retirar el EcoSmart (limitador de flujo) de la ducha. Con una presión superior a 0,2 MPa no está permitido retirar el EcoSmart.

## Datos técnicos

Presión en servicio: max. 0,6 MPa  
 26521XXX Presión recomendada en servicio: 0,2 - 0,4 MPa  
 26551XXX Presión recomendada en servicio: 0,17 - 0,4 MPa  
 26531XXX Presión recomendada en servicio: 0,15 - 0,4 MPa  
 (1 MPa = 10 bar = 147 PSI)  
 Temperatura del agua caliente: max. 60°C  
 Desinfección térmica: max. 70°C / 4 min

El producto ha sido concebido exclusivamente para agua potable.

## Descripción de símbolos

 **Dimensiones** (ver página 19)



**Diagrama de circulación**

(ver página 19)



**Manejo** (ver página 18)



**Repuestos** (ver página 18)

XXX = Acabados  
 000 = cromado  
 400 = cromado/blanco



**Limpiar** (ver página 22) y folleto anexo



**Marca de verificación** (ver página 24)

**Montaje**

**ver página 18**



## Veiligheidsinstructies

- ⚠ Bij de montage moeten ter voorkoming van kniel- en snijwonden handschoenen worden gedragen.
- ⚠ Het contact van de douchestraal met gevoelige lichaamsdelen (bijv. ogen) moet worden voorkomen. Er moet voldoende afstand tussen douche en lichaam aangehouden worden.
- ⚠ De douche uitsluitend toepassen in badkamers ten behoeve van lichaamsreiniging.

## Montage-instructies

- Het bij de hoofddouche verpakte zeefje moet worden ingebouwd om vuil uit de waterleiding te weren. Vuil uit de leidingen kan de werking van de hoofddouche negatief beïnvloeden en/of de hoofddouche beschadigen. Voor deze schade is Hansgrohe niet verantwoordelijk.
- Bij een druk onder 0,2 MPa (2 bar) mag de gebruikte EcoSmart (debietbegrenzer) uit de sproeier verwijderd worden. Bij een druk boven 0,2 MPa mag de EcoSmart niet verwijderd worden.

## Technische gegevens

Werkdruk: max. max. 0,6 MPa  
 26521XXX Aanbevolen werkdruk: 0,2 - 0,4 MPa  
 26551XXX Aanbevolen werkdruk: 0,17 - 0,4 MPa  
 26531XXX Aanbevolen werkdruk: 0,15 - 0,4 MPa  
 (1 MPa = 10 bar = 147 PSI)  
 Temperatuur warm water: max. 60°C  
 Thermische desinfectie: max. 70°C / 4 min

Het product is uitsluitend ontworpen voor drinkwater!

## Symboolbeschrijving

 **Maten** (zie blz. 19)



**Doorstroombiagram**

(zie blz. 19)



**Bediening** (zie blz. 18)



**Service onderdelen** (zie blz. 18)

XXX = Kleuren  
 000 = verchromd  
 400 = verchromd/wit



**Reinigen** (zie blz. 22) en bijgevoegde brochure



**Keurmerk** (zie blz. 24)

**Montage**

**zie blz. 18**





### Sikkerhedsanvisninger

- △ Ved monteringen skal der bruges handsker for at undgå kvæstelser og snitsår.
- △ Bruserstrålens kontakt med sensitive områder (f.eks. øjne) skal undgås. Der skal være en tilstrækkelig afstand mellem bruseren og kroppen.
- △ Bruseren må kun bruges til at bruse, til hygiejne og rengøring af kroppen.

### Monteringsanvisninger

- Den vedlagte smudsfangssi skal indsættes i bruseren for at undgå snavs fra rørsystemet. Indskyllet snavs kan have indflydelse på bruserens funktion og/eller føre til beskadigelser på håndbruserens funktionsdele.
- Ved et tryk under 0,2 MPa (2 bar) må den isatte EcoSmart (gennemstrømningsbegrænser) fjernes fra bruseren. Ved et tryk over 0,2 MPa må EcoSmart ikke fjernes.

### Tekniske data

Driftstryk:	max. 0,6 MPa
26521XXX Anbefalet driftstryk:	0,2 - 0,4 MPa
26551XXX Anbefalet driftstryk:	0,17 - 0,4 MPa
26531XXX Anbefalet driftstryk:	0,15 - 0,4 MPa
(1 MPa = 10 bar = 147 PSI)	
Varmt vandstemperatur:	max. 60°C
Termisk desinfektion:	max. 70°C / 4 min

Produktet er udelukkende beregnet til drikkevand!

### Symbolbeskrivelse

 **Målene** (se s. 19)

 **Gennemstrømningsdiagram**  
(se s. 19)

 **Brugsanvisning** (se s. 18)

 **Reserve dele** (se s. 18)

XXX = Overflade  
000 = Krom  
400 = Krom/Hvid

 **Rengøring** (se s. 22) og vedlagt brochure

 **Godkendelse** (se s. 24)

**Montering**  
**se s. 18**

### Avisos de segurança

- △ Durante a montagem devem ser utilizadas luvas de protecção, de modo a evitar ferimentos resultantes de entalamentos e de cortes.
- △ Deve-se evitar o contacto dos jactos de água com partes do corpo sensíveis (p. ex. olhos). É necessário manter uma distância suficiente entre o chuveiro e o corpo.
- △ O chuveiro só pode ser utilizado para fins de higiene pessoal.

### Avisos de montagem

- O filtro de rede deve ser colocado para proteger o chuveiro de areias e resíduos provenientes da tubagem. Resíduos e areias podem danificar componentes, ou provocar mau funcionamento do chuveiro; as avarias assim provocadas anulam a nossa responsabilidade e anulam a nossa garantia.
- O EcoSmart pode ser desmontado do chuveiro a uma pressão inferior a 0,2 MPa (2 bar). O EcoSmart não pode ser desmontado a uma pressão superior a 0,2 MPa.

### Dados Técnicos

Pressão de funcionamento:	max. 0,6 MPa
26521XXX Pressão de func. recomendada:	0,2 - 0,4 MPa
26551XXX Pressão de func. recomendada:	0,17 - 0,4 MPa
26531XXX Pressão de func. recomendada:	0,15 - 0,4 MPa
(1 MPa = 10 bar = 147 PSI)	
Temperatura da água quente:	max. 60°C
Desinfecção térmica:	max. 70°C / 4 min

Este produto foi única e exclusivamente concebido para água potável!

### Descrição do símbolo

 **Medidas** (ver página 19)

 **Fluxograma**  
(ver página 19)

 **Funcionamento** (ver página 18)

 **Peças de substituição** (ver página 18)

XXX = Acabamentos  
000 = cromado  
400 = cromado/branco

 **Limpeza** (ver página 22) e brochura em anexo

 **Marca de controlo** (ver página 24)

**Montagem**  
**ver página 18**



**! Wskazówki bezpieczeństwa**

- △ Aby uniknąć zranień, takich jak zgniecenia czy przecięcia, podczas montażu należy nosić rękawice.
- △ Należy unikać kontaktu strumienia wypytywającego z głowicy z wrażliwymi częściami ciała (np. oczami). Należy zachowywać odpowiednią odległość pomiędzy głowicą a ciałem.
- △ Prysznic może być używany tylko do kąpieli, higieny i czyszczenia ciała.

**Wskazówki montażowe**

- Znajdujące się przy prysznicu sitko musi zostać zainstalowane, aby zatrzymać zanieczyszczenia z instalacji. Przedostające się zanieczyszczenia mogą mieć ujemny wpływ na działanie i/lub prowadzić do usterek w działaniu elementów prysznicza. Za powstanie z tego tytułu szkody firma Hansgrohe nie ponosi odpowiedzialności.
- Przy ciśnieniu poniżej 0,2 MPa (2 bar) można usunąć z prysznicza zastosowany EcoSmart (ogranicznik przepływu). Przy ciśnieniu powyżej 0,2 MPa EcoSmart nie może zostać usunięty.

**Dane techniczne**

Ciśnienie robocze:	maks. 0,6 MPa
26521XXX Zalecane ciśnienie robocze:	0,2 - 0,4 MPa
26551XXX Zalecane ciśnienie robocze:	0,17 - 0,4 MPa
26531XXX Zalecane ciśnienie robocze:	0,15 - 0,4 MPa
(1 MPa = 10 bar = 147 PSI)	
Temperatura wody gorącej:	maks. 60°C
Dezynfekcja termiczna:	maks. 70°C / 4 min

Produkt stworzono wyłącznie do wody pitnej!

**Opis symbolu**

**Wymiary** (patrz strona 19)



**Schemat przepływu**

(patrz strona 19)



**Obsługa** (patrz strona 18)



**Części serwisowe** (patrz strona 18)

XXX = Kody kolorów  
000 = chrom  
400 = chrom/biały



**Czyszczenie** (patrz strona 22) i dołączona broszura

**Znak jakości** (patrz strona 24)



**Montaż**

**patrz strona 18**

6

**! Bezpečnostní pokyny**

- △ Pro zabránění řezným zraněním a pohmožděním je nutné při montáži nosit rukavice.
- △ Je nutné zabránit kontaktu vodních paprsků sprchy s měkkými částmi těla (např. očima). Je nutné dodržovat dostatečný odstup mezi sprchou a tělem.
- △ Sprcha smí být používána pouze za účelem koupání a tělesné hygieny.

**Pokyny k montáži**

- Do přívodu musí být zabudováno se sprchou dodávané sítko, aby zachycovalo nečistoty vyplavené z vodovodní sítě. Vyplavené nečistoty mohou ovlivnit funkci sprchy a nebo mohou vést i k jejímu poškození. Na takto vzniklé škody se nevztahuje záruka firmy Hansgrohe.
- Pokud je hodnota tlaku nižší než 0,2 MPa (2 bary) je možné ze sprchy demontovat zabudovaný EcoSmart (omezovač průtoku). Pokud je hodnota tlaku vyšší než 0,2 MPa nesmíte EcoSmart demontovat.

**Technické údaje**

Provozní tlak:	max. 0,6 MPa
26521XXX Doporučený provozní tlak:	0,2 - 0,4 MPa
26551XXX Doporučený provozní tlak:	0,17 - 0,4 MPa
26531XXX Doporučený provozní tlak:	0,15 - 0,4 MPa
(1 MPa = 10 bar = 147 PSI)	
Teplota horké vody:	max. 60°C
Teplná desinfekce:	max. 70°C / 4 min

Výrobky Hansgrohe jsou vhodné pro přímý kontakt s pitnou vodou.

**Popis symbolů**

**Rozměry** (viz strana 19)



**Diagram průtoku**

(viz strana 19)



**Ovládání** (viz strana 18)



**Servisní díly** (viz strana 18)

XXX = Kód povrchové úpravy  
000 = chrom  
400 = chrom/bílá



**Čištění** (viz strana 22) a přiložená brožura

**Zkušební značka** (viz strana 24)



**Montáž**

**viz strana 18**





## **Bezpečnostné pokyny**

- △ Pri montáži musíte nosiť rukavice, aby ste predišli poškodeniam a rezným poraneniam.
- △ Vyhýbajte sa kontaktu vodného lúča sprchy s citlivými miestami tela (napr. oči). Dodržiavajte dostatočnú vzdialenosť medzi sprchou a telom.
- △ Sprcha sa smie používať len na účely kúpania a telesnej hygieny.

## **Pokyny pre montáž**

- Do prívodu musí byť zabudované so sprchou dodávané sítka, aby zachytilo nečistoty vyplavené z vodovodnej siete. Vyplavené nečistoty môžu ovplyvniť funkciu sprchy, alebo spôsobiť jej poškodenie. Na takto vzniknuté škody sa nevzťahuje záruka firmy Hansgrohe.
- Pri tlaku pod 0,2 MPa (2 bar) sa smie nasadený EcoSmart (obmedzovač prietoku) odstrániť zo sprchy. Pri tlaku nad 0,2 MPa sa EcoSmart nesmie odstrániť.

## **Technické údaje**

Prevádzkový tlak:	max. 0,6 MPa
26521XXX Doporučený prevádzkový tlak:	0,2 - 0,4 MPa
26551XXX Doporučený prevádzkový tlak:	0,17 - 0,4 MPa
26531XXX Doporučený prevádzkový tlak:	0,15 - 0,4 MPa
(1 MPa = 10 bar = 147 PSI)	
Teplota teplej vody:	max. 60°C
Termická dezinfekcia:	max. 70°C / 4 min

Výrobok je koncipovaný výhradne pre pitnú vodu!

## **安全技巧**

- △ 装配时为避免挤压和切割受伤，必须戴上手套。
- △ 必须避免让身体敏感部位（如眼睛）接触到莲蓬头喷水。必须保持莲蓬头与人头之间有足够的距离。
- △ 该莲蓬头仅允许作淋浴、卫生保健和身体清洁目的使用。

## **安装提示**

- 必须装上花洒所附带的滤网密封垫，以过滤管道里的杂质污物。杂质污物会影响花洒的功能和/或损坏花洒的功能部件，由此而产生的产品损坏不属于汉斯格雅的保修范围。
- 当水压低于 0.2 MPa (2 bar) 时，允许拆卸龙头上的 Ecosmart (流量限制装置)。而当水压高于 0.2 MPa 时，则禁止拆卸 Ecosmart。

## **技术参数**

工作压强:	最大 0,6 MPa
26521XXX 推荐工作压强:	0,2 - 0,4 MPa
26551XXX 推荐工作压强:	0,17 - 0,4 MPa
26531XXX 推荐工作压强:	0,15 - 0,4 MPa
(1 MPa = 10 bar = 147 PSI)	
热水温度:	最大 60°C
热力消毒:	最大 70°C / 4 分钟

该产品专为饮用水设计！

## **Popis symbolov**

**Rozmery** (viď strana 19)



**Diagram prietoku**

(viď strana 19)



**Obsluha** (viď strana 18)



**Servisné diely** (viď strana 18)

XXX = Farebné označenie

000 = chróm

400 = chróm/biela



**Čistenie** (viď strana 22) a priložená brožúra

**Osvedčenie o skúške** (viď strana 24)



## **符号说明**

**大小** (参见第 19 页)



**流量示意图**

(参见第 19 页)



**操作** (参见第 18 页)



**备用零件** (参见第 18 页)

XXX = 颜色代码

000 = 镀铬

400 = 镀铬/白色



**清洗** (参见第 22 页) 并附有小手册

**检验标记** (参见第 24 页)



**Montáž**  
**viď strana 18**



**安装**  
**参见第 18 页**



## Biztonsági utasítások

- △ A szerelésnél a zúzódások és vágási sérülések elkerülése érdekében kesztyűt kell viselni.
- △ Kerülni kell a zuhanyugár érintkezését érzékeny testrészekkel (pl. szemek). Be kell tartani a megfelelő távolságot a zuhanyfej és a test között.
- △ A zuhanyt csak fürdő- higiéniai- és tisztítási célra szabad használni.

## Szerelési utasítások

- A kézi zuhanyhoz csomagolt szűrőtömítést be kell szerelni a vízhálózatból származó szennyeződések kiküszöbölésére. A beáramló szennyeződések akadályozhatják és / vagy teljesen tönkre is tehetik a zuhany funkcióit. Az ezekből adódó károkért a Hansgrohe nem felel.
- 0,2 MPa (2 bar) alatti nyomás esetén el szabad távolítani a behelyezett EcoSmart-ot (átfolyás korlátozót) a zuhanyfejből. 0,2 MPa feletti nyomás esetén az EcoSmart-ot nem szabad eltávolítani.

## Műszaki adatok

Üzemi nyomás:	max. 0,6 MPa
26521XXX Ajánlott üzemi nyomás:	0,2 - 0,4 MPa
26551XXX Ajánlott üzemi nyomás:	0,17 - 0,4 MPa
26531XXX Ajánlott üzemi nyomás:	0,15 - 0,4 MPa
(1 MPa = 10 bar = 147 PSI)	
Forróvíz hőmérséklet:	max. 60°C
Termikus fertőtlenítés:	max. 70°C / 4 perc

A terméket kizárólag ivóvízhez tervezték!



## Turvallisuusohjeet

- △ Asennuksessa on käytettävä käsineitä puristumien ja viiltojen aiheuttamien tapaturmien estämiseksi.
- △ Suihkuveden kontaktia herkkien ruumiinosien (esim. silmien) kanssa on vältettävä. Suihkuun ja vartalon välissä on oltava riittävä väli.
- △ Suihkua saa käyttää vain kylpy-, hygienian ja kehonpuhdistustarkoituksiin.

## Asennusohjeet

- Käsisuihkuun mukana toimitettu siittiiviste on asennettava paikalleen, jotta liian huuhtoutuminen vesijohtoverkostosta käsisuihkuun estyy. Huuhtoutuvat likahiukkasot voivat häiritä suihkuun toimintaa tai vahingoittaa toimintaosia, Hansgrohe ei vastaa tästä aiheutuneista vahingoista.
- Paineen ollessa alle 0,2 MPa (2 bar) asennetun EcoSmartin (virtausrajoittimen) saa ottaa pois suihkusta. Paineen ollessa yli 0,2 MPa EcoSmartia ei saa ottaa pois.

## Tekniset tiedot

Käyttöpainne:	max. 0,6 MPa
26521XXX Suositeltu käyttöpainne:	0,2 - 0,4 MPa
26551XXX Suositeltu käyttöpainne:	0,17 - 0,4 MPa
26531XXX Suositeltu käyttöpainne:	0,15 - 0,4 MPa
(1 MPa = 10 bar = 147 PSI)	
Kuuman veden lämpötila:	max. 60°C
Lämpödesinfektio:	max. 70°C / 4 min

Tuote on suunniteltu käytettäväksi ainoastaan juomaveden kanssa!

## Szimbólumok leírása

**Méretet** (lásd a oldalon 19)



**Átfolyási diagramm**

(lásd a oldalon 19)



**Használat** (lásd a oldalon 18)



**Tartozékok** (lásd a oldalon 18)

XXX = Színkódolás  
 000 = króm  
 400 = króm/fehér



**Tisztítás** (lásd a oldalon 22) és mellékelt brossúrával

**Vizsgajel** (lásd a oldalon 24)



## Merkin kuvaus

**Mitat** (katso sivu 19)



**Virtausdiagrammi**

(katso sivu 19)



**Käyttö** (katso sivu 18)



**Varaosat** (katso sivu 18)

XXX = Värikoodaus  
 000 = kromi  
 400 = kromi/valkoinen



**Puhdistus** (katso sivu 22) ja oheinen esite

**Koestusmerkki** (katso sivu 24)



## Szerelés

lásd a oldalon 18



## Asennus

katso sivu 18





## Säkerhetsanvisningar

- △ Handskar ska bäras under monteringsarbetet så att man kan undvika kläm- och skärskadorgen werden.
- △ Undvik att rikta duschstrålarna mot känsliga kroppsdelar (t. ex. ögonen). Det måste finnas ett tillräckligt stort avstånd mellan duschen och kroppen.
- △ Duschen får bar användas till dusch-, bad- och personlig hygien.

## Monteringsanvisningar

- Silpackningen som följer med duschen måste monteras för att undvika att smuts från ledningsnätet tränger in. Smuts som spolats in kan påverka funktionerna och/eller leda till skador på funktionsdelar i duschen. Hansgrohe fransäger sig allt ansvar för skador som kan härledas till detta.
- Vid ett tryck under 0,2 MPa (2 bar) får insatt EcoSmart (flödeskontroll) tas ut ur duschen. Vid ett tryck över 0,2 MPa får EcoSmart inte tas bort.

## Tekniska data

Driftstryck:	max. 0,6 MPa
26521XXX Rek. driftstryck:	0,2 - 0,4 MPa
26551XXX Rek. driftstryck:	0,17 - 0,4 MPa
26531XXX Rek. driftstryck:	0,15 - 0,4 MPa
(1 MPa = 10 bar = 147 PSI)	
Varmvattentemperatur:	max. 60°C
Termisk desinfektion:	max. 70°C / 4 min

Produkten är enbart avsedd för dricksvatten!

## Saugumo technikos nurodymai

- △ Apsaugai nuo užspaudimo ir įsijpavimo montavimo metu mūvėkite pirštines.
- △ Būtinyje vengti dušo vandens srovės kontakto su jautriomis kūno vietomis (pvz., akimis). Todėl būtinyje laikytis tinkamo atstumo nuo dušo.
- △ Dušo galva naudojama tik maudymosi, higieniniais ir kūno švarinimo tikslais.

## Montavimo instrukcija

- Tinklelis, kuris yra rankų dušas pakuotėje, privalo būti įstatytas, kad būtų apsaugota nuo išorės nešvarumų. Nešvarumai gali pakenkti rankų dušas funkcionalumui ir (arba) sugadinti rankų dušas funkcines dalis. Tokiu atveju "Hansgrohe" atsakomybės neprišima.
- Jei slėgis yra žemesnis nei 0,2 MPa (2 bar) iš dušo galima išmontuoti EcoSmart (vandens srauto ribotuva). Jei slėgis yra aukštesnis nei 0,2 MPa EcoSmart išmontuoti negalima.

## Techniniai duomenys

Darbinis slėgis:	ne daugiau kaip 0,6 MPa
26521XXX Rekomenduojamas slėgis:	0,2 - 0,4 MPa
26551XXX Rekomenduojamas slėgis:	0,17 - 0,4 MPa
26531XXX Rekomenduojamas slėgis:	0,15 - 0,4 MPa
(1 MPa = 10 barų = 147 PSI)	
Karšto vandens temperatūra:	ne daugiau kaip 60°C
Terminis dezinfekavimas:	ne daugiau kaip 70°C / 4 min

Produktas skirtas tik geriamajam vandeniui!

## Symbolbeskrivning



**Måtten** (se sidan 19)



**Flödesschema**

(se sidan 19)



**Hantering** (se sidan 18)



**Reservdelar** (se sidan 18)

XXX = Färgkodning

000 = krom

400 = krom/vit



**Rengöring** (se sidan 22) och medföljande broschyr

**Testsigill** (se sidan 24)



**Montering**  
se sidan 18

## Simbolio aprašymas



**Įšmatavimai** (žr. psl. 19)



**Pralaidumo diagrama**

(žr. psl. 19)



**Eksploatacija** (žr. psl. 18)



**Atsarginės dalys** (žr. psl. 18)

XXX = Spalvos

000 = chrom

400 = chrom/balta



**Valymas** (žr. psl. 22) ir pridedama brošiūra

**Bandyimo pažyma** (žr. psl. 24)



**Montavimas**  
žr. psl. 18





## Sigurnosne upute

- Prilikom montaže se radi sprječavanja prignječenja i posjekotina moraju nositi rukavice.
- Mora se izbjegavati kontakt mlaza iz tuša s osjetljivim dijelovima tijela (npr. očima). Tijelo korisnika mora biti dovoljno udaljeno od tuša.
- Tuš se smije primjenjivati samo za kupanje, tuširanje i osobnu higijenu.

## Upute za montažu

- Filter potrebno je ugraditi kako bi se regulirao protok vode i smanjio dotok prljavštine. Za eventualna oštećenja uzrokovana prljavštinom proizvođač Hansgrohe nije odgovoran.
- Ako je tlak manji od 0,2 MPa (2 bara), iz tuša se smije ukloniti umetnuti EcoSmart (limitator protoka). Ako je tlak veći od 0,2 MPa, EcoSmart se ne smije uklanjati.

## Tehnički podaci

Najveći dopušteni tlak:	tlak 0,6 MPa
26521XXX Preporučeni tlak:	0,2 - 0,4 MPa
26551XXX Preporučeni tlak:	0,17 - 0,4 MPa
26531XXX Preporučeni tlak:	0,15 - 0,4 MPa
(1 MPa = 10 bar = 147 PSI)	
Temperatura vruće vode:	tlak 60 °C
Termička dezinfekcija:	tlak 70 °C / 4 min

Proizvod je koncipiran isključivo za pitku vodu!



## Güvenlik uyarıları

- Montaj esnasında ezilme ve kesilme gibi yaralanmaları önlemek için eldiven kullanılmalıdır.
- Püskürtme başlıklarının hassas organlara teması (örn. gözler) önlenmelidir. Püskürtücü ile beden arasında yeterli mesafe bırakılmalıdır.
- Su püskürtücü yalnızca banyo, hijyen ve yıkanma amaçları için kullanılabilir.

## Montaj açıklamaları

- El duşu kafasına eklenmiş olan süzgeç contası, boru şebekesinden sızan kirlerin önüne geçmek için, yerine monte edilmektedir. İçeri sızan bu kirler duşun fonksiyonunu sekteleyebilir ve/veya duşun fonksiyon parçaları üzerinde hasarlara sebep olabilir, bu yüzden meydana gelen hasarlardan Hansgrohe sorumlu tutulamaz.
- 0,2 MPa (2 bar) altındaki bir basınçta kullanılan EcoSmart (akış sınırlayıcısı) fışkiyeden çıkarılabilir. 0,2 MPa üzerindeki bir basınçta ise EcoSmart çıkarılmamalıdır.

## Teknik bilgiler

İşletme basıncı:	azami 0,6 MPa
26521XXX Tavsiye edilen işletme basıncı:	0,2 - 0,4 MPa
26551XXX Tavsiye edilen işletme basıncı:	0,17 - 0,4 MPa
26531XXX Tavsiye edilen işletme basıncı:	0,15 - 0,4 MPa
(1 MPa = 10 bar = 147 PSI)	
Sıcak su sıcaklığı:	azami 60 °C
Termik dezenfeksiyon:	azami 70 °C / 4 dak

Ürün sadece şebeke suyu için tasarlanmıştır!

## Opis simbola

 **Mjere** (pogledaj stranicu 19)

 **Dijagram protoka**  
(pogledaj stranicu 19)

 **Upotreba** (pogledaj stranicu 18)

 **Rezervni djelovi** (pogledaj stranicu 18)

XXX = Boje  
000 = krom  
400 = krom/bijela

 **Čišćenje** (pogledaj stranicu 22) i  
priložena brošura

 **Oznaka testiranja** (pogledaj stranicu 24)

## Sastavljanje

10 **pogledaj stranicu 18**

## Simge açıklaması



 **Ölçüleri** (bakınız sayfa 19)

 **Akış diyagramı**  
(bakınız sayfa 19)

 **Kullanımı** (bakınız sayfa 18)

 **Yedek Parçalar** (bakınız sayfa 18)

XXX = Renkler  
000 = krom  
400 = krom/beyaz

 **Temizleme** (bakınız sayfa 22) ve  
birlikte verilen broşür  
 **Kontrol işareti** (bakınız sayfa 24)

## Montajı

 **bakınız sayfa 18**



### Instrucțiuni de siguranță

- Δ La montare utilizați mănuși pentru evitarea contuziunilor și tăierii mâinilor.
- Δ Evitați contactul jetului de apă cu părțile de corp sensibile (de ex. ochii). Țineți dușul la o distanță corespunzătoare de corp.
- Δ Dușul poate fi utilizat doar în scopuri de spălare, igienizare și de întreținere a igienei corporale.

### Instrucțiuni de montare

- Montați garnitura de filtru livrată împreună cu capătul de duș de mână pentru evitarea pătrunderii impurităților din rețeaua de alimentare. Impuritățile pătrunse pot influența funcționarea aparatului și/sau provoca deteriorarea capătului de duș. Garanția nu acoperă aceste daune.
- În cazul unei presiuni sub 0,2 MPa (2 bar) limitatorul de debit EcoSmart utilizat poate fi demontat din duș. În cazul unei presiuni de peste 0,2 MPa, limitatorul de debit EcoSmart nu poate fi îndepărtat.

### Date tehnice

Presiune de funcționare:	max. 0,6 MPa
26521XXX Presiune de funcționare recomandată:	0,2 - 0,4 MPa
26551XXX Presiune de funcționare recomandată:	0,17 - 0,4 MPa
26531XXX Presiune de funcționare recomandată:	0,15 - 0,4 MPa
(1 MPa = 10 bar = 147 PSI)	
Temperatura apei calde:	max. 60°C
Dezinfecție termică:	max. 70°C / 4 min

Produsul este destinat exclusiv pentru apă potabilă.

### Descrierea simbolurilor

 **Dimensiuni** (vezi pag. 19)



**Diagrama de debit**  
(vezi pag. 19)



**Utilizare** (vezi pag. 18)



**Piese de schimb** (vezi pag. 18)  
XXX = Coduri de culori  
000 = crom  
400 = crom/alb



**Curățare** (vezi pag. 22) și broșura alăturată



**Certificat de testare** (vezi pag. 24)

**Montare**  
vezi pag. 18



### Υποδειξεις ασφαλείας

- Δ Για να αποφύγετε τραυματισμούς κατά τη συναρμολόγηση πρέπει να φοράτε γάντια.
- Δ Η επαφή δέσμης νερού του ντους με ευαίσθητες περιοχές του σώματος (π.χ. μάτια) πρέπει να αποφεύγεται. Διατηρείτε επαρκή απόσταση ανάμεσα στο ντους και το σώμα.
- Δ Το ντους επιτρέπεται να χρησιμοποιείται μόνο για το μπάνιο, τον καθαρισμό και την υγιεινή του σώματος.

### Οδηγίες συναρμολόγησης

- Πρέπει να εγκατασταθεί το παρέμβυσμα φίλτρου που συνοδεύει τον καταιονιστήρα κατά τέτοιο τρόπο, ώστε να αποφεύγονται ρύποι που προέρχονται από το δίκτυο ύδρευσης. Οι ρύποι από το δίκτυο ύδρευσης μπορούν να επηρεάσουν αρνητικά και/ή να προσξενήσουν ζημιά στα λειτουργικά τμήματα του καταιονιστήρα (ντους). Τέτοιου είδους ζημιές δεν καλύπτονται από την εγγύηση Hansgrohe.
- Όταν η πίεση είναι κάτω από 0,2 MPa (2 bar) μπορεί να αφαιρεθεί το τοποθετημένο EcoSmart (μειωτής ροής) από το ντους. Όταν η πίεση υπερβεί τα 0,2 MPa δεν επιτρέπεται η αφαίρεση του EcoSmart.

### Τεχνικά Χαρακτηριστικά

Λειτουργία πίεσης:	έως 0,6 MPa
26521XXX Συνιστώμενη λειτουργία πίεσης:	0,2 - 0,4 MPa
26551XXX Συνιστώμενη λειτουργία πίεσης:	0,17 - 0,4 MPa
26531XXX Συνιστώμενη λειτουργία πίεσης:	0,15 - 0,4 MPa
(1 MPa = 10 bar = 147 PSI)	
Θερμοκρασία ζεστού νερού:	έως 60°C
Θερμική απολύμανση:	έως 70°C / 4 min

Το προϊόν έχει σχεδιαστεί αποκλειστικά για πόσιμο νερό!

### Περιγραφή συμβόλων

 **Διαστάσεις** (βλ. Σελίδα 19)



**Διάγραμμα ροής**  
(βλ. Σελίδα 19)



**Χειρισμός** (βλ. Σελίδα 18)



**Ανταλλακτικά** (βλ. Σελίδα 18)  
XXX = Χρώματα  
000 = Επιχρωμωμένο  
400 = Επιχρωμωμένο/λευκό



**Καθαρισμός** (βλ. Σελίδα 22) και συνημμένο φυλλάδιο  
**Σήμα ελέγχου** (βλ. Σελίδα 24)



**Συναρμολόγηση**  
βλ. Σελίδα 18

**Varnostna opozorila**

- △ Pri montaži je treba nositi rokavice, da se preprečijo poškodbe zaradi zmečkanja ali urezov.
- △ Izogibati se je treba stiku prhalnega curka z občutljivi mi deli telesa (npr. očmi). Med telesom in prho mora biti vedno zadosten razmik.
- △ Prha se sme uporabljati le z namenom vzdrževanja higijene oziroma umivanja kopalnice in telesa.

**Navodila za montažo**

- Filter, ki je priložen ročni prhi, je potrebno vgraditi, da prho zaščitimo pred umazanijo iz vodovodne napeljave. Umazanija lahko okvari ali poškoduje dele ročne prhe. Za tako nastalo škodo Hansgrohe ne odgovarja.
- Pri tlaku pod 0,2 MPa (2 bar) lahko iz prhe odstranite vstavljen EcoSmart (omejevalnik pretoka). Pri tlaku nad 0,2 MPa omejevalnika EcoSmart ne smete odstraniti.

**Tehnični podatki**

Delovni tlak:	maks. 0,6 MPa
26521XXX Priporočeni delovni tlak:	0,2 - 0,4 MPa
26551XXX Priporočeni delovni tlak:	0,17 - 0,4 MPa
26531XXX Priporočeni delovni tlak:	0,15 - 0,4 MPa
(1 MPa = 10 bar = 147 PSI)	
Temperatura tople vode:	maks. 60 °C
Termična dezinfekcija:	maks. 70 °C / 4 min

Proizvod je zasnovan izključno za sanitarno vodo!

**Ohutusjuhised**

- △ Kandke paigaldamisel muljumis- ja löikevigastuste vältimiseks kindaid.
- △ Duši veejoad ei tohi kokku puutuda tundlike kehaosadega (nt silmad). Jätke duši ja keha vahele piisav vahe.
- △ Dušši tohib kasutada ainult vanniskäimiseks, hügieeniks ja keha pesemiseks.

**Paigaldamisjuhised**

- Kaitsmaks dušši torust tuleva mustuse eest, on vaja paigaldada dušiga kaasasolev mustusesöel. Sissetulev mustus võib funktsioneerimist kahjustada ja/või rikkuda duši detaile. Sellest tulenevate kahjude eest Hansgrohe ei vastuta.
- Kui rõhk on alla 0,2 MPa (2 bar), võib läbivoolupiiraja EcoSmart dušist ära võtta. Kui rõhk on üle 0,2 MPa, ei tohi EcoSmart'i eemaldada.

**Tehnilised andmed**

Töörõhk	maks. 0,6 MPa
26521XXX Soovitatav töörõhk:	0,2 - 0,4 MPa
26551XXX Soovitatav töörõhk:	0,17 - 0,4 MPa
26531XXX Soovitatav töörõhk:	0,15 - 0,4 MPa
(1 MPa = 10 baari = 147 PSI)	
Kuuma vee temperatuur:	maks. 60 °C
Termiline desinfektsioon:	maks. 70 °C / 4 min

Toode on ette nähtud eranditult joogivee jaoks!

**Opis simbola**

 **Mere** (glejte stran 19)

 **Diagram pretoka**  
(glejte stran 19)

 **Upravljanje** (glejte stran 18)

 **Rezervni deli** (glejte stran 18)  
XXX = Barve  
000 = krom  
400 = krom/bela

 **Čiščenje** (glejte stran 22) in priložena brošura

 **Preskusni znak** (glejte stran 24)

**Sümbolite kirjeldus**

 **Mõõtude** (vt lk 19)

 **Läbivooludiagramm**  
(vt lk 19)

 **Kasutamine** (vt lk 18)

 **Varuosad** (vt lk 18)  
XXX = Värvid  
000 = kroom  
400 = kroom/valge

 **Puhastamine** (vt lk 22) ja kaasasolev brošüür

 **Kontrollsertifikaat** (vt lk 24)



**Montaža**  
**glejte stran 18**



**Paigaldamine**  
**vt lk 18**



### Drošības norādes

-  Montāžas laikā, lai izvairītos no saspiedumiem un iegriezumiem, nepieciešams nēsāt cimdus.
-  Nepieciešams izvairīties no dušas strūkļas tieša kontakta ar jutīgām ķermeņa daļām (piem., acīm). Nepieciešams ievērot pietiekošu attālumu starp dušu un ķermeni.
-  Dušu drīkst izmantot vienīgi vannošānās, higiēnas un ķermeņa tīrīšanas nolūkiem.

### Norādījumi montāžai



- Jāņemontē dušas komplektā esošais filtrs, lai novērstu ne-tīrību iekļūšanu no ūdens vada. Ieskatotie netīrumi var traucēt dušas funkciju un / vai arī izraisīt rokas dušas daļu bojājumus, par kuriem Hansgrohe nenes atbildību.
- Ja spiediens ir zemāks 0,2 MPa (2 bar), izmantoto EcoSmart (caurteces ierobežotājs) var izņemt no dušas. Ja spiediens ir lielāks par 0,2 MPa, EcoSmart nedrīkst izņemt.

### Tehniskie dati

Darba spiediens:	maks. 0,6 MPa
26521XXX leteicamais darba spiediens:	0,2 - 0,4 MPa
26551XXX leteicamais darba spiediens:	0,17 - 0,4 MPa
26531XXX leteicamais darba spiediens:	0,15 - 0,4 MPa
(1 MPa = 10 bar = 147 PSI)	
Karstā ūdens temperatūra:	maks. 60°C
Termiskā dezinfekcija :	maks. 70°C / 4 min

Izstrādājums ir paredzēts tikai dzeramajam ūdenim!

### Sigurnosne napomene

-  Prilikom montaže se radi sprečavanja prignječenja i posekotina moraju nositi rukavice.
-  Mora se izbegavati kontakt mlaza iz tuša sa osetljivim delovima tela (npr. očima). Telo korisnika mora biti na dovoljnom odstojanju od tuša.
-  Tuš sme da se koristi samo za kupanje, tuširanje i ličnu higijenu.

### Instrukcije za montažu

- Obavezno ugradite mrežicu upakovanu s tušem, čime sprečavate ulazak prljavštine iz vodovoda. Prljavština može dovesti do delimičnog ili potpunog oštećenja delova tuša. Za eventualna oštećenja uzrokovana prljavštinom proizvođač Hansgrohe nije odgovoran.
- Ako je pritisak manji od 0,2 MPa (2 bara), iz tuša se sme ukloniti umetnuti EcoSmart (ograničavač protoka). Ukoliko je pritisak veći od 0,2 MPa, EcoSmart se ne sme uklanjati.

### Tehnički podaci

Radni pritisak:	maks. 0,6 MPa
26521XXX Preporučeni radni pritisak:	0,2 - 0,4 MPa
26551XXX Preporučeni radni pritisak:	0,17 - 0,4 MPa
26531XXX Preporučeni radni pritisak:	0,15 - 0,4 MPa
(1 MPa = 10 bar = 147 PSI)	
Temperatura vruće vode:	maks. 60°C
Termička dezinfekcija:	maks. 70°C / 4 min

Proizvod je koncipiran isključivo za pijaću vodu!

### Simbolu nozīme

 **Izmērus** (skat. lpp. 19)

 **Caurplūdes diagramma**  
(skat. lpp. 19)

 **Lietošana** (skat. lpp. 18)

 **Rezerves daļas**(skat. lpp. 18)  
XXX = Krāsu kodi  
000 = hroma  
400 = hroma/balta

 **Tīrīšana** (skat. lpp. 22) un klāt pievienotais buklets

 **Pārbaudes zīme** (skat. lpp. 24)

**Montāža**  
skat. lpp. 18

### Opis simbola

 **Mere** (vidi stranu 19)

 **Dijagram protoka**  
(vidi stranu 19)

 **Rukovanje** (vidi stranu 18)

 **Rezervni delovi**(vidi stranu 18)  
XXX = Oznake boja  
000 = hrom  
400 = hrom/bela

 **Čišćenje** (vidi stranu 22) i priložena brošura

 **Ispitni znak** (vidi stranu 24)

**Montaža**  
vidi stranu 18





## Sikkerhetshenvisninger

- △ Bruk hansker under montasjonen for å unngå klem- og kuttskader.
- △ Dusjstrålen skal ikke komme i kontakt med ømfintlige kroppsdeler (f.eks. øynene). Overhold en tilstrekkelig avstand mellom dusjen og kroppen.
- △ Dusjen skal kun brukes for bading, til hygieneformål og til kroppsgjengjøring

## Montagehenvisninger

- Silpakningen som er levert med dusjen skal bygges inn for å forhindre at smuss spyles inn fra ledningsnett. Innspylt smuss kan påvirke funksjonen negativt og/eller kan medføre skader på hånddusjens funksjonsdeler. Hansgrohe påtar seg inget ansvar for skader som resulteres av dette.
- Ved trykk under 0,2 MPa (2 bar) skal den innsatte EcoSmart (strømningsbegrenser) fjernes fra dusjen. Ved trykk over 0,2 MPa skal ikke EcoSmart fjernes.

## Tekniske data

Driftstrykk	maks. 0,6 MPa
26521XXX Anbefalt driftstrykk:	0,2 - 0,4 MPa
26551XXX Anbefalt driftstrykk:	0,17 - 0,4 MPa
26531XXX Anbefalt driftstrykk:	0,15 - 0,4 MPa
(1 MPa = 10 bar = 147 PSI)	
Varmtvannstemperatur	maks. 60°C
Termisk desinfisering:	maks. 70°C / 4 min

Produktet er utelukkende designet for drikkevann!

## Udhözime sigurie

- △ Për të evituar lëndimet e pickimeve ose të prerjeve gjatë procesit të montimit duhet që të vishni doreza.
- △ Kontakti i valëve të dushit me pjesët e ndjeshme të trupit (p.sh. me sytë) duhet që të shmanget. Midis dushit dhe trupit duhet që të mbahet një distancë e mjaftueshme.
- △ Dushi duhet të përdoret vetëm për qëllimet e banjave, të higjienës dhe të larjes së trupit.

## Udhözime për montimin

- Sita që i kemi bashkëngjitur spërkatëses duhet përdorur për të evituar thithjen e papastërtive nga rrjeti i ujësjellësit. Ndotjet mund të dëmtojë pjesë funksionale të spërkatëses. Hansgrohe nuk merr përgjegjësinë për dëmet e shkaktuara në këtë mënyrë.
- Tek një presion nën 0,2 MPa (2 bar) guxon që të hiqet EcoSmart nga shpërkatësja. Tek presioni mbi 0,2 MPa nuk guxon që të hiqet EcoSmart.

## Të dhëna teknike

Presioni gjatë punës	maks. 0,6 MPa
26521XXX Presioni i rekomanduar:	0,2 - 0,4 MPa
26551XXX Presioni i rekomanduar:	0,17 - 0,4 MPa
26531XXX Presioni i rekomanduar:	0,15 - 0,4 MPa
(1 MPa = 10 bar = 147 PSI)	
Temperatura e ujit të ngrohtë	maks. 60°C
Dezinfektim Termik:	maks. 70°C / 4 min

Produkti është projektuar ekskluzivisht për ujë të pijshëm!

## Symbolbeskrivelse

 **Mål** (se side 19)

 **Gjennomstrømningsdiagram**

(se side 19)

 **Betjening** (se side 18)

 **Servicelever** (se side 18)

XXX = Fargekode  
000 = krom  
400 = krom/hvit

 **Rengjøring** (se side 22) og vedlagt brosjyre

 **Prøvemerk** (se side 24)

**Montasje**  
**se side 18**

## Përshkrimi i simbolit

 **Përmasat** (shih faqen 19)

 **Diagrami i qarkullimit**

(shih faqen 19)

 **Përdorimi** (shih faqen 18)

 **Pjesët e servisit** (shih faqen 18)

XXX = Kodimi me anë të ngjyrave  
000 = krom  
400 = krom/e bardhë

 **Pastrimi** (shih faqen 22) dhe broshura bashkëngjitur



 **Shenja e kontrollit** (shih faqen 24)

**Montimi**  
**shih faqen 18**





## Указания по технике безопасности

-  Во время монтажа следует надеть перчатки во избежание прищемления и порезов.
-  Не допускайте попадания струи воды из разбрызгивателя на чувствительные части тела (например, на глаза). Разбрызгиватель следует устанавливать на достаточном расстоянии от тела.
-  Источник разбрызгивания разрешается использовать только в гигиенических целях для принятия ванны и личной гигиены.

## Указания по монтажу

- Для предотвращения попадания частиц грязи из водопроводной сети необходимо установить фильтр, прилагаемый к ручному душу. Частицы грязи могут нарушить отдельные функции и/или привести к повреждению функциональных деталей ручного душа, Hansgrohe не несет ответственность за повреждения вследствие отсутствия фильтра.
- При давлении ниже 0,2 МПа (2 бар) используемый EcoSmart (ограничитель потока) можно удалить из душа. При давлении выше 0,2 МПа EcoSmart удалять нельзя.

## Технические данные

Рабочее давление:	не более. 0,6 МПа
26521XXX Рекомендуемое рабочее давление:	0,2 - 0,4 МПа
26551XXX Рекомендуемое рабочее давление:	0,17 - 0,4 МПа
26531XXX Рекомендуемое рабочее давление:	0,15 - 0,4 МПа
(1 МПа = 10 bar = 147 PSI)	
Температура горячей воды:	не более. 60 °С
Термическая дезинфекция:	не более. 70 °С / 4 мин

Изделие предназначено исключительно для питьевой воды!

## Описание символов

**Размеры** (см. стр. 19)

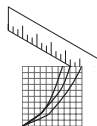

**Схема потока**  
(см. стр. 19)



**Эксплуатация** (см. стр. 18)



**Комплект** (см. стр. 18)

XXX = Цветная кодировка  
000 = хром  
400 = хром/белый



**Очистка** (см. стр. 22) и прилагаемая брошюра



**Знак технического контроля**  
(см. стр. 24)



**Монтаж см. стр. 18**



## Указания за безопасност

- ⚠ При монтажа трябва да се носят ръкавици, за да се избегнат наранявания поради притискане или порязване.
- ⚠ Трябва да се избягва контакта на струите на разпръсквателя с чувствителни части на тялото (напр. очите). Между разпръсквателя и тялото трябва да се спазва достатъчно разстояние.
- ⚠ Позволено е използването на разпръсквателя само за къпане, хигиена и цели на почистване на тялото.

## Указания за монтаж

- Опакованото заедно с разпръсквателя уплътнение с цедка трябва да се монтира, за да се избегне натрупване на замърсявания от водопроводната мрежа. Натрупването на замърсявания може да наруши функцията и/или да доведе до увреждане на функционалните части на разпръсквателя, Hansgrohe не носи отговорност за получените се по този начин щети.
- При налягане под 0,2 МПа (2 bar) поставеният EcoSmart (ограничител на протичаве) може да се отстранява от разпръсквателя. При налягане над 0,2 МПа EcoSmart не бива да се отстранява.

## Технически данни

Работно налягане:	макс. 0,6 МПа
26521XXX Препоръчително работно налягане:	0,2 - 0,4 МПа
26551XXX Препоръчително работно налягане:	0,17 - 0,4 МПа
26531XXX Препоръчително работно налягане:	0,15 - 0,4 МПа
(1 МПа = 10 bar = 147 PSI)	
Температура на горещата вода:	макс. 60 °C
Термична дезинфекция:	макс. 70 °C / 4 мин

Продуктът е разработен само за питейна вода!

## Описание на символите

**Размери** (вижте стр. 19)



**Диаграма на потока**  
(вижте стр. 19)



**Обслужване** (вижте стр. 18)

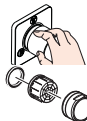

**Сервизни части** (вижте стр. 18)

XXX = Цветово кодиране

000 = хром

400 = хром/бял

**Почистване** (вижте стр. 22) и приложена брошура



**Контролен знак** (вижте стр. 24)



**Монтаж вижте стр. 18**





## ⚠️ تنبيهات الأمان

⚠️ يجب إرتداء قفازات ليد أثناء التركيب لتجنب حدوث أخطار الإنحشار أو الجروح.

⚠️ يجب تجنب حدوث إتصال مباشر بين الماء الخارج من رأس الدش وبين أجزاء الجسم الحساسة (مثل العينين). يجب وجود مسافة كافية بين رأس الدش والجسم.

⚠️ يسمح باستخدام الدش فقط لأغراض الإستحمام، والأغراض الصحية، وتنظيف الجسم.

## تعليمات التركيب

• يجب إدخال الحلقة الشبكية لحماية الدش اليدوي من الأوساخ التي تحملها شبكة المواسير. حيث تؤدي الأوساخ الواردة إلى حدوث أعطال أو / وقد تتسبب في تلف أجزاء من من الدش. ومثل هذه الأعطال تلغي كافة المطالبات الخاصة بالمسؤولية أو الضمان.

• يجب عزل EcoSmart (تركيبه خديد انسياب الماء) من رأس الدوش إذا كان معدل الضغط أقل من 0,2 باسكال (2 بار). ممنوع عزل EcoSmart إذا كان الضغط يزيد عن 0,2 باسكال.

## المواصفات الفنية

ضغط التشغيل: الحد الأقصى 0,6 ميجاباسكال  
26521XXX ضغط التشغيل  
الموصى به: 0,4 - 0,2 ميجاباسكال  
26551XXX ضغط التشغيل  
الموصى به: 0,4 - 0,17 ميجاباسكال  
26531XXX ضغط التشغيل  
الموصى به: 0,4 - 0,15 ميجاباسكال  
(1 ميجاباسكال = 10 بار = 147 PSI)  
درجة حرارة الماء الساخن: الحد الأقصى 60°C  
تعقيم حراري: الحد الأقصى 70°C / 4 الدقيقة  
المنتج مخصص فقط لماء الشرب!

## وصف الرمز

أبعاد (راجع صفحة 19)



رسم للصرف

(راجع صفحة 19)



التشغيل (راجع صفحة 18)



قطع الغيار (راجع صفحة 18)

XXX = الألوان

000 = كروم

400 = كروم / أبيض



التنظيف (راجع صفحة 22) والكتيب المرفق



شهادة اختبار (راجع صفحة 24)



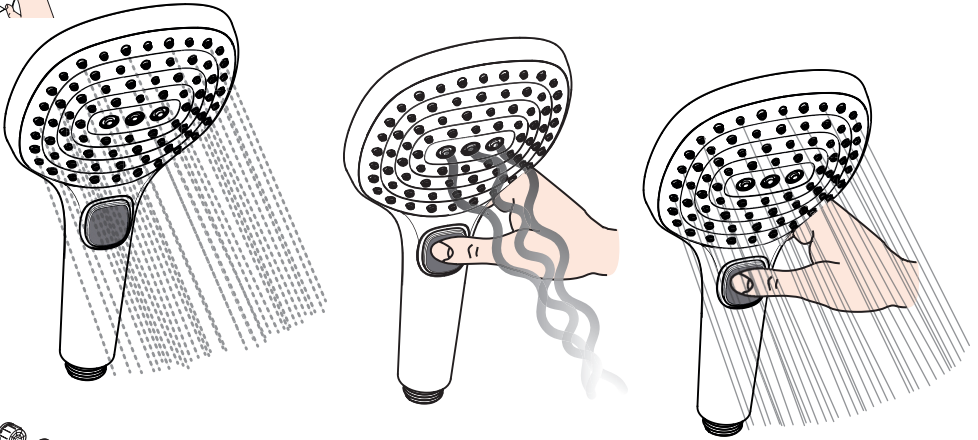
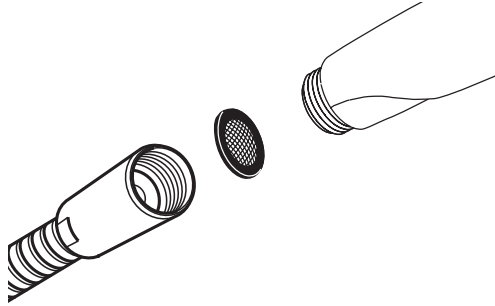

95659000  
**EcoSmart**® 9 l/min

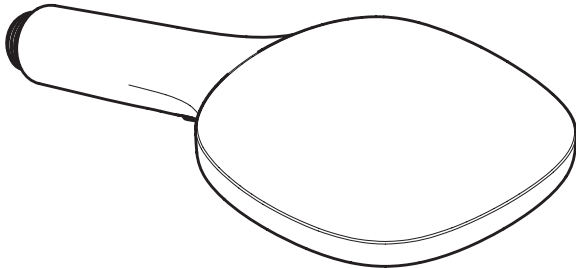
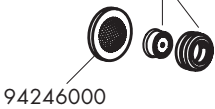

# Raindance Select E 120

26521000 / 26521400

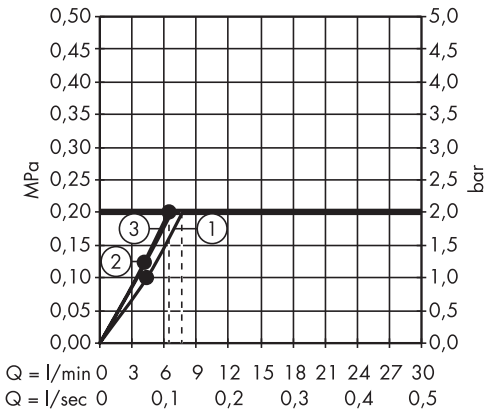
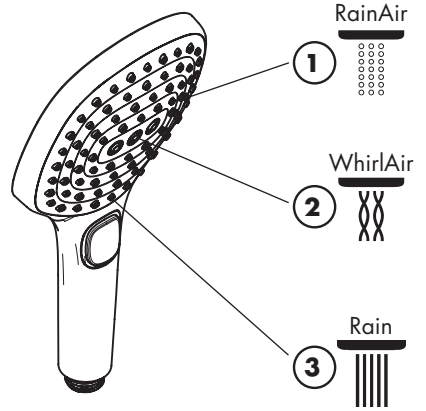
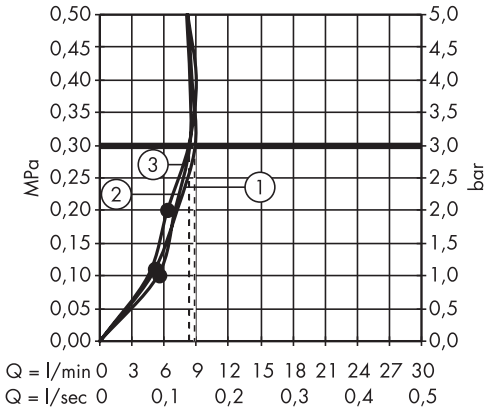
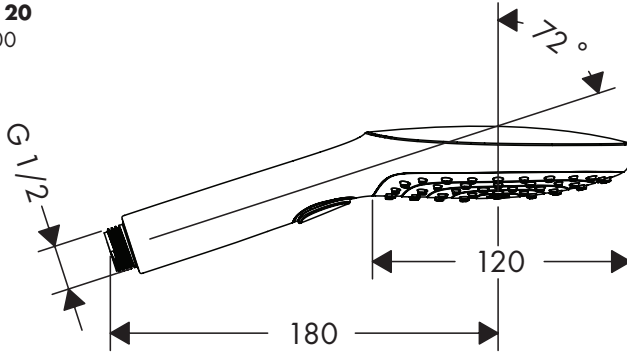



# Raindance Select S 120

26531000 / 26531400

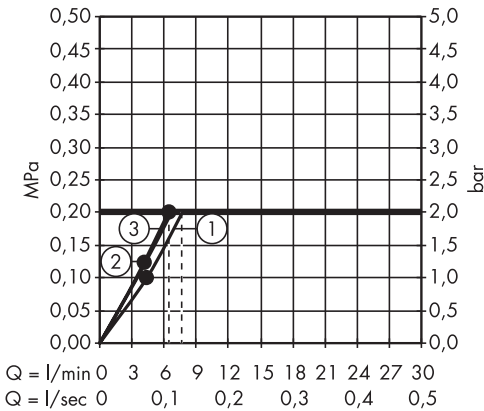
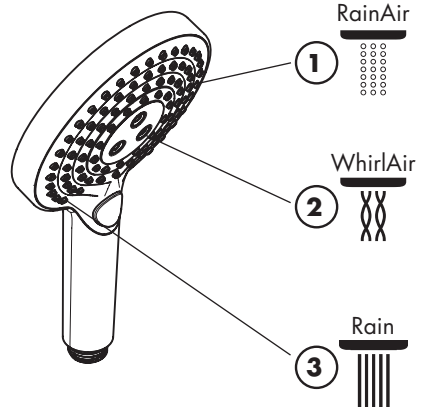
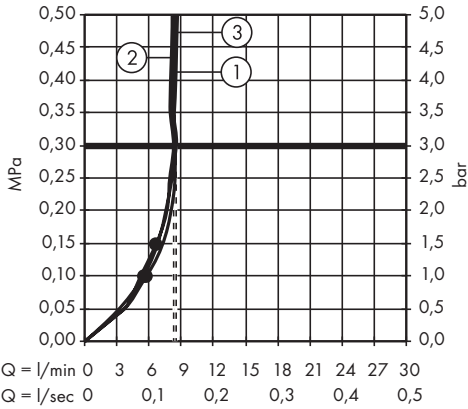
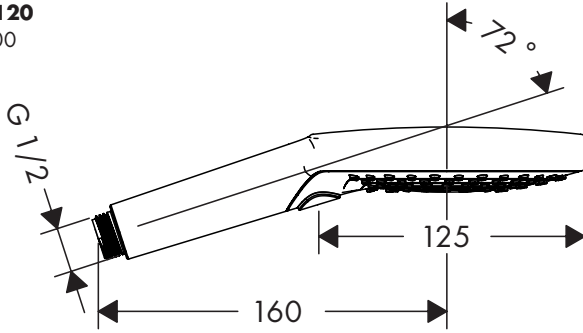

# Raindance Select E 150

26551000 / 26551400

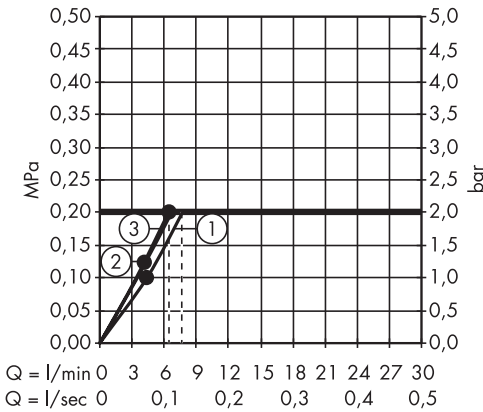
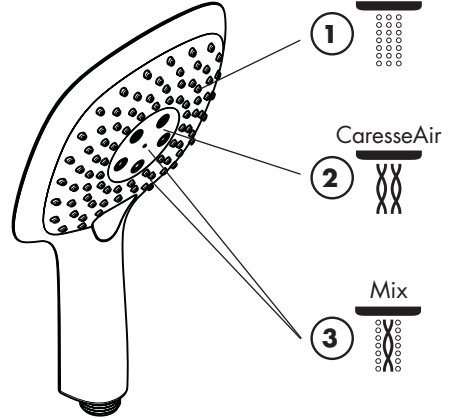
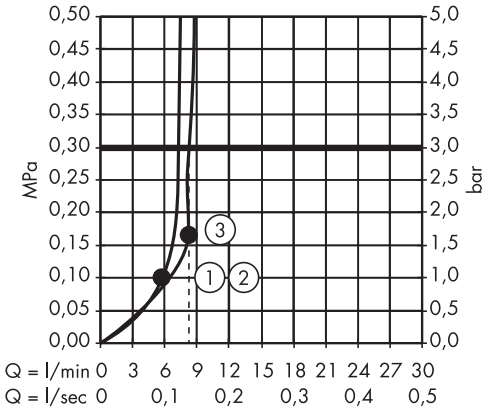
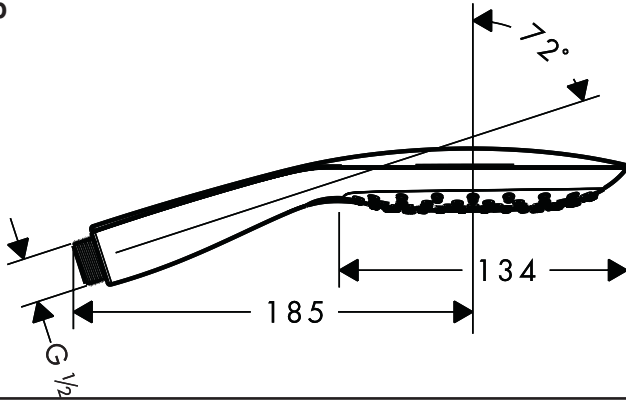

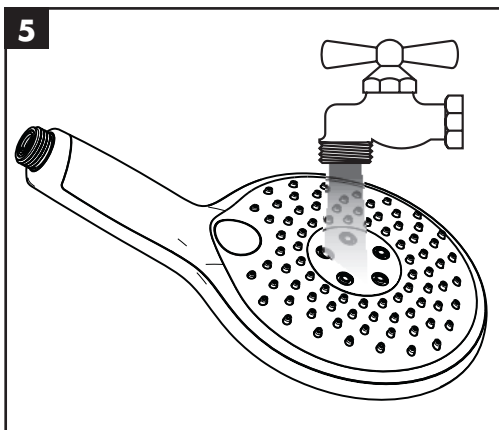
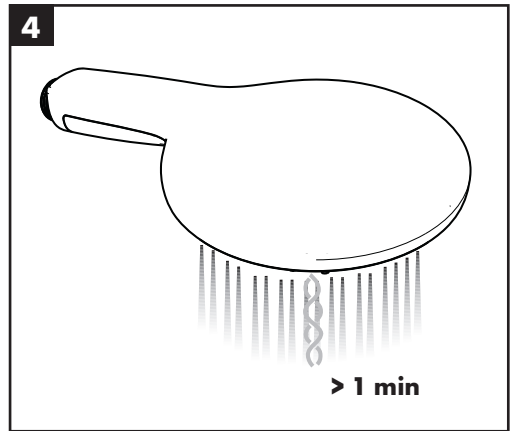
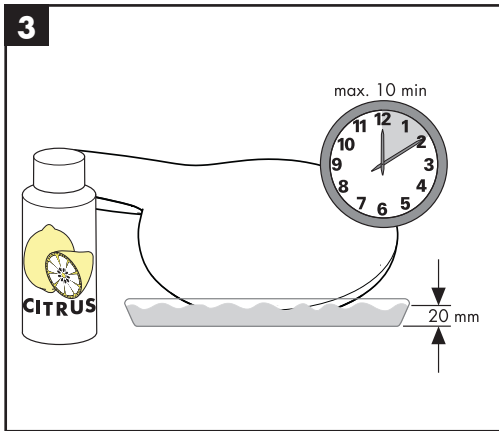
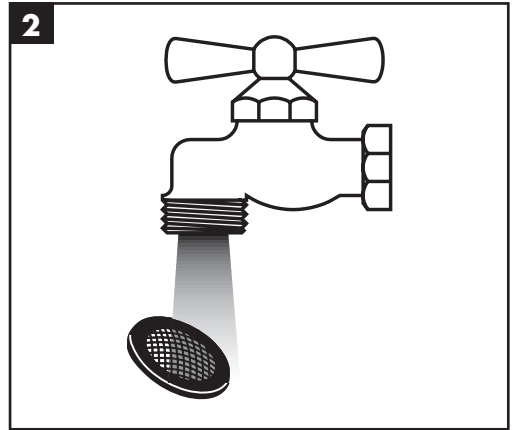
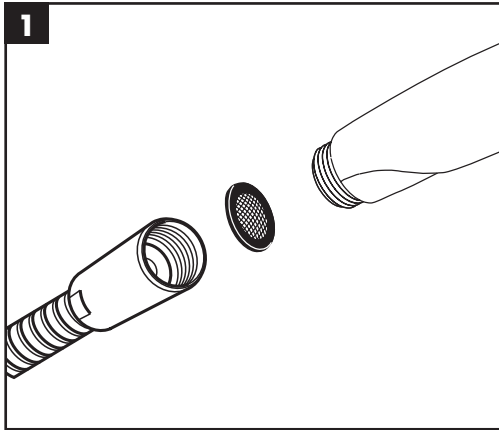





---

	<b>P-IX</b>	<b>DVGW</b>	<b>SVGW</b>	<b>ACS</b>	<b>WRAS</b>	<b>KIWA</b>	<b>NF</b>
<b>26521000 /</b> <b>26521400</b>				X			
<b>26531000 /</b> <b>26531400</b>							
<b>26551000 /</b> <b>26551400</b>							

---